

## **IMPORTANT NOTICE**

All rights to this manual are owned solely by SATEL OY (referred to in this user guide as SATEL). All rights reserved. The copying of this manual (without the written permission from the owner) by printing, copying, recording or by any other means, or the full or partial translation of the manual to any other language, including all programming languages, using any electrical, mechanical, magnetic, optical, manual or other methods or devices is forbidden.

SATEL reserves the right to change the technical specifications or functions of its products, or to discontinue the manufacture of any of its products or to discontinue the support of any of its products, without any written announcement and urges its customers to ensure, that the information at their disposal is valid.

SATEL software and programs are delivered "as is". The manufacturer does not grant any kind of warranty including guarantees on suitability and applicability to a certain application. Under no circumstances is the manufacturer or the developer of a program responsible for any possible damages caused by the use of a program. The names of the programs as well as all copyrights relating to the programs are the sole property of SATEL. Any transfer, licensing to a third party, leasing, renting, transportation, copying, editing, translating, modifying into another programming language or reverse engineering for any intent is forbidden without the written consent of SATEL.

**SATEL PRODUCTS HAVE NOT BEEN DESIGNED, INTENDED NOR INSPECTED TO BE USED IN ANY LIFE SUPPORT RELATED DEVICE OR SYSTEM RELATED FUNCTION NOR AS A PART OF ANY OTHER CRITICAL SYSTEM AND ARE GRANTED NO FUNCTIONAL WARRANTY IF THEY ARE USED IN ANY OF THE APPLICATIONS MENTIONED.**

Salo, FINLAND 2011

Copyright: 2011 SATEL Oy

No part of this document may be reproduced, transmitted or stored in a retrieval system in any form or by any means without the prior written permission of SATEL Oy.

This document is provided in confidence and must not be distributed to third parties without the express permission of SATEL Oy.

## RESTRICTIONS ON USE

SATELLINE-EASy Pro 35W radio modems have been designed to operate on frequency ranges, the exact use of which differs from one region and/or country to another. The user of a radio modem must take care that the said device is not operated without the permission of the local authorities on frequencies other than those specifically reserved and intended for use without a specific permit.

The allowed max output power depends on the type of station.

SATELLINE-EASy Pro 35W is allowed to be used in the following countries, either on licence free channels or on channels where the operation requires a licence. More detailed information is available at the local frequency management authority.

Countries: AT, AU, BE, BG, CA, CH, CY, CZ, DE, DK, EE, ES, FI, FR, GB, GR, HU, IE, IS, IT, LT, LU, LV, MT, NL, NO, PL, PT, RO, RU, SE, SK and US.

**WARNING!** Users of SATELLINE-EASy Pro 35W radio modems in North America should be aware, that due to the allocation of the frequency band 406.0 – 406.1 MHz for government use only, the use of radio modem on this frequency band without a proper permit is strictly forbidden.

## PRODUCT CONFORMITY

SATEL Oy hereby declares that SATELLINE-EASy Pro 35W radio modem is in compliance with the essential requirements (radio performance, electromagnetic compatibility and electrical safety) and other relevant provisions of Directive 1999/5/EC. Therefore the equipment is labelled with the following CE-marking. The notification sign informs users that the operating frequency range of the device is not harmonised throughout the market area, and the local spectrum authority should be contacted before the usage of the radio modem is used.



### DECLARATION of CONFORMITY

In Accordance with  
1999/5/EC Directive

of the European Parliament and of the Council of 9 March 1999 on radio equipment and telecommunications terminal equipment and the mutual recognition of their conformity

Doc No: SATEL-DC-RTTE-093  
 Manufacturer: SATEL Oy  
 Address: POB 142, (Meriniitynkatu 17), 24101 Salo, Finland

Products :	Type	Model
	SATEL-TA18	SATELLINE-EASy Pro 35W

We, the manufacturer of the above mentioned products, hereby declare that these products conform to the essential requirements of the European Union directive 1999/5/EC. This Declaration of Conformity is based on the following documents:

Doc. No	Type of Product	Test Specification	Laboratory / Date of Issue
166783R	SATELLINE-EASy Pro 35W	EN 300 113-2 V.1.4.2	NEMKO / Espoo 28.2.2011
166783F	SATELLINE-EASy Pro 35W	EN 301 489-1 V.1.8.1, -5 V.1.3.1	NEMKO / Espoo 28.2.2011
166783S	SATELLINE-EASy Pro 35W	EN 60950-1:2005 (2 <sup>nd</sup> Ed)	NEMKO / Espoo 28.4.2011

Salo on the 2<sup>nd</sup> of May, 2011

SATEL OY  
  
 Pekka Aura  
 CEO



SATEL Oy  
 PO.Box 142, FI-24101 SALO, FINLAND  
 Street: Meriniitynkatu 17, FI-24100 SALO, FINLAND  
 Tel. +358 2 777 7800, Fax +358 2 777 7810  
 E-mail: info@satel.com, www.satel.com

 **SATEL**<sup>®</sup>  
 WIRELESS WORLD - LOCAL SOLUTION

## **WARRANTY AND SAFETY INSTRUCTIONS**

Read these safety instructions carefully before using the product:

- Warranty will be void, if the product is used in any way that is in contradiction with the instructions given in this manual, or if the radio modem housing has been opened or tampered with.
- The radio modem is only to be operated at frequencies allocated by local authorities, and without exceeding the given maximum allowed output power ratings. SATEL and its distributors are not responsible, if any products manufactured by it are used in unlawful ways.
- The devices mentioned in this manual are to be used only according to the instructions described in this manual. Faultless and safe operation of the devices can be guaranteed only if the transport, storage, operation and handling of the devices are appropriate. This also applies to the maintenance of the products.
- To prevent damage both the radio modem and any terminal devices must always be switched OFF before connecting or disconnecting the serial connection cable. It should be ascertained that different devices used have the same ground potential. Before connecting any power cables the output voltage of the power supply should be checked.
- If the device uses an outdoor antenna, the antenna cable jacket must be grounded.

## TABLE OF CONTENTS

<b>IMPORTANT NOTICE .....</b>	<b>1</b>
<b>RESTRICTIONS ON USE .....</b>	<b>2</b>
<b>PRODUCT CONFORMITY.....</b>	<b>3</b>
<b>WARRANTY AND SAFETY INSTRUCTIONS .....</b>	<b>4</b>
<b>TABLE OF CONTENTS .....</b>	<b>5</b>
<b>INTRODUCTION .....</b>	<b>9</b>
<b>1 SATELLINE-EASY PRO 35W TECHNICAL SPECIFICATIONS .....</b>	<b>10</b>
<b>1.1 Default settings .....</b>	<b>12</b>
<b>2 OTHER FEATURES .....</b>	<b>14</b>
<b>3 SATELLINE-EASY PRO 35W SPECIAL FEATURES .....</b>	<b>15</b>
<b>3.1 Call Sign .....</b>	<b>15</b>
<b>3.2 Temperature protection of RF power amplifier .....</b>	<b>15</b>
<b>3.3 Protection of current .....</b>	<b>16</b>
<b>4 SERIAL INTERFACE .....</b>	<b>17</b>
<b>5 USER INTERFACE.....</b>	<b>18</b>
<b>5.1 LED-indicators .....</b>	<b>18</b>
<b>5.2 Display and push buttons .....</b>	<b>18</b>
5.2.1 SATELLINE-EASy Pro 35W LCD-display after power-up.....	19
<b>6 CONNECTION INTERFACES.....</b>	<b>21</b>
<b>6.1 RS-232 interface.....</b>	<b>21</b>
<b>6.2 Connectors.....</b>	<b>21</b>
<b>7 RF INTERFACE .....</b>	<b>22</b>

<b>7.1</b>	<b>Transmitter.....</b>	<b>22</b>
<b>7.2</b>	<b>Receiver.....</b>	<b>23</b>
<b>7.3</b>	<b>Priority RX/TX.....</b>	<b>23</b>
<b>7.4</b>	<b>Forward Error Correction .....</b>	<b>24</b>
<b>7.5</b>	<b>Error checking .....</b>	<b>24</b>
<b>7.6</b>	<b>Dual radio function, separate RX/TX-frequencies .....</b>	<b>24</b>
<b>7.7</b>	<b>Free Channel Scan (FCS) .....</b>	<b>25</b>
<b>7.8</b>	<b>User data whitening .....</b>	<b>26</b>
<b>8</b>	<b>TRANSPARENT DATA TRANSMISSION.....</b>	<b>27</b>
<b>8.1</b>	<b>Serial interface, data format .....</b>	<b>27</b>
<b>8.2</b>	<b>Handshake lines .....</b>	<b>28</b>
8.2.1	CTS-line .....	28
8.2.2	CD-line .....	28
8.2.3	RTS-line.....	29
<b>8.3</b>	<b>Timing and delays during data transmission .....</b>	<b>29</b>
8.3.1	Data buffering in the radio data modem.....	29
8.3.2	Pause length .....	30
8.3.3	TX delay.....	31
<b>8.4</b>	<b>Testing.....</b>	<b>31</b>
<b>9</b>	<b>SETTINGS.....</b>	<b>33</b>
<b>9.1</b>	<b>Programming Mode.....</b>	<b>33</b>
<b>9.2</b>	<b>Changing parameters using a terminal device.....</b>	<b>34</b>
9.2.1	Changing the settings .....	34
9.2.2	Restoring factory settings .....	35
9.2.3	Changing frequency (active radio channel frequency) .....	36
9.2.4	Changing reference frequency .....	37
9.2.5	Changing channel spacing.....	37
9.2.6	Changing radio settings .....	38
9.2.7	Free channel scan .....	39
9.2.8	Changing addressing settings (primary and secondary RX- and TX-addresses) .....	40
9.2.9	Changing serial port settings (Port 1) .....	41
9.2.10	Modification of handshaking functions.....	43
9.2.11	Special functions .....	45
9.2.12	Modification of routing.....	46
9.2.13	Activating tests.....	50

9.2.14	Restoring factory settings .....	50
9.2.15	Info .....	50
9.2.16	Saving modified settings into the permanent memory .....	51
9.2.17	Updating Firmware .....	51
<b>9.3</b>	<b>Changing parameters using the LCD-display .....</b>	<b>51</b>
9.3.1	Changing frequency (frequency of the active TX/RX radio channel) .....	52
9.3.2	Changing radio settings (transmitter power and receiver sensitivity).....	55
9.3.3	Changing addressing.....	56
9.3.4	Changing serial port settings (Port 1) .....	58
9.3.5	Modification of handshaking functions.....	59
9.3.6	Selecting special functions .....	60
9.3.7	Activating tests.....	60
9.3.8	Restoring factory settings .....	61
9.3.9	Adjusting the contrast of the LCD-display .....	61
9.3.10	Saving modified values into the internal memory .....	62
<b>9.4</b>	<b>Changing parameters using the SL-commands .....</b>	<b>62</b>
9.4.1	Frequency.....	63
9.4.2	Addressing .....	64
9.4.3	Radio parameters .....	64
9.4.4	Other functions .....	65
<b>10</b>	<b>REPEATER MODE AND ADDRESSING.....</b>	<b>66</b>
<b>10.1</b>	<b>Repeater.....</b>	<b>66</b>
<b>10.2</b>	<b>Addressing .....</b>	<b>67</b>
10.2.1	Connection between two points .....	69
10.2.2	System of one base station and several substations .....	69
<b>10.3</b>	<b>Using repeaters and addresses in the same system .....</b>	<b>70</b>
10.3.1	System with several repeaters.....	70
10.3.2	Repeater chain using address pairs .....	71
10.3.3	Repeater chain using dual addressing.....	72
10.3.4	Redundant repeater chain .....	72
<b>11</b>	<b>MESSAGE ROUTING .....</b>	<b>73</b>
<b>11.1</b>	<b>Introduction to Message Routing.....</b>	<b>73</b>
11.1.1	Features of Message Routing .....	74
11.1.2	Limitations of Message Routing .....	74
11.1.3	Getting started with Message Routing .....	74
11.1.4	SaTerm and the configuration of the Message Routing .....	75
11.1.5	Manual configuration of the Message Routing.....	75
11.1.6	Configuration of the protocol in Message Routing .....	76
<b>11.2</b>	<b>Operating modes of Message Routing .....</b>	<b>77</b>
<b>11.3</b>	<b>Detailed description of Message Routing.....</b>	<b>77</b>

11.3.1	Source Mode Routing .....	77
11.3.2	Virtual Mode Routing .....	78
11.3.3	Overhop function in Source Mode Routing .....	78
11.3.4	Network ID .....	79
<b>12</b>	<b>INSTALLATION .....</b>	<b>80</b>
<b>12.1</b>	<b>Installation of a Radio Data Modem .....</b>	<b>80</b>
12.1.1	RS-232 Wiring .....	80
12.1.2	Fuse .....	81
12.1.3	Power supply .....	81
<b>12.2</b>	<b>Antenna installation .....</b>	<b>82</b>
12.2.1	Mobile equipment .....	82
12.2.2	Base stations .....	82
12.2.3	General antenna installation instructions.....	82
<b>13</b>	<b>DESIGNING SYSTEMS .....</b>	<b>86</b>
<b>13.1</b>	<b>Factors affecting the quality and distance of the radio connection ....</b>	<b>86</b>
<b>13.2</b>	<b>Radio field strength .....</b>	<b>87</b>
<b>14</b>	<b>CHECK LIST .....</b>	<b>88</b>
<b>15</b>	<b>ACCESSORIES .....</b>	<b>89</b>
<b>15.1</b>	<b>RS-232 cables and adapters.....</b>	<b>89</b>
<b>15.2</b>	<b>Power cable .....</b>	<b>89</b>
<b>15.3</b>	<b>RF-cables .....</b>	<b>89</b>
<b>15.4</b>	<b>Antennas .....</b>	<b>90</b>
<b>15.5</b>	<b>Filters and lightning protectors .....</b>	<b>90</b>
<b>16</b>	<b>APPENDIX A .....</b>	<b>91</b>
<b>17</b>	<b>APPENDIX B .....</b>	<b>92</b>
<b>17.1</b>	<b>Functional delays .....</b>	<b>92</b>
<b>17.2</b>	<b>Transmission related delays.....</b>	<b>92</b>
17.2.1	Transmission delays when the radio TX frequency is changed.....	93
17.2.2	Transmission delays when using a 12.5 kHz radio channel.....	93
17.2.3	Transmission delays using a 25 kHz radio channel .....	95

## INTRODUCTION

SATEL OY is a Finnish electronics and Telecommunications Company specialising in the design and manufacture of wireless data communication products. SATEL designs, manufactures and sells radio modems intended for use in applications ranging from data transfer to alarm relay systems. End users of SATEL products include both public organisations and private individuals.

SATEL OY is the leading European manufacturer of radio modems. SATEL radio modems have been certified in most European countries and also in many non-European countries.

SATELLINE-EASy Pro 35W is an IP67 classified UHF radio modem with a high power (35 W) transmitter, wide 70 MHz tuning range (403...473 MHz) in one hardware and selectable channel spacing. The SATELLINE-EASy Pro 35W can offer radio speeds up to 19.2 kbps and has a selectable serial interface speed between 300 ... 38 400 bps.

SATELLINE-EASy Pro 35W includes a built-in LCD display, offering the user both new features and increased flexibility. No longer do you have to rely on access to a PC or terminal device to check or alter the configuration of the unit, now this can be achieved by viewing the LCD-display and using the four (4) push buttons. The display is also a useful tool in testing the radio connection between radio modems.

SATELLINE-EASy Pro 35W facilitates the construction of large radio networks using the built-in *Message Routing* function, which is both fully transparent to the user and can be used with most system protocols.

The radio modem also offers option of error correction, utilising the FEC-method (Forward Error Correction). FEC can be used to minimise errors caused by noisy channels.

## 1 SATELLINE-EASy Pro 35W technical specifications

SATELLINE-EASy complies with the following international standards:

- o EN 300 113-2
- o EN 301 489 (EMC-requirements)
- o EN 60950 (Safety Standard)
- o FCC CFR47 part 90

	RECEIVER	TRANSMITTER	Note!
Frequency Range	403...473 MHz		
Tuning Range	70 MHz		
Channel Spacing	12.5 kHz / 20 kHz / 25 kHz		Programmable
Spurious Radiations	< 2 nW	According to EN 55022 and FCC CFR47 part 90	
Duty Cycle 35W *)	100% (@22°C) 20 min 100% (@35 °C) 13 min 40% No limit		
Duty Cycle 10W *)	100% (@22°C) No limit 100% (@35 °C) 50 min 40% No limit		
Frequency Error Tolerance	< 1 kHz		
Sensitivity	-114 dBm @ 12.5 kHz -111 dBm @ 25 kHz (BER < 10 E-3)		FEC ON See: Note 1
Co-channel Rejection	> -12 dB		FEC ON
Adjacent Channel Selectivity	> 47 dB @12.5 kHz > 52 dB @ 25 kHz		FEC ON
Selectivity	67 dB @ ±50 kHz		FEC ON
Intermodulation Attenuation	> 60 dB		FEC ON
Blocking	> 86 dB		FEC ON
Spurious Rejection	> 60 dB		FEC ON
Power Consumption	< 1.8 W	110 W typical@ 35 W, min 12 Vdc	
Power Save Mode Consumption	SLEEP State:0,4 W typical		
Communication Mode	Half-Duplex		
Type of Emission	F1D		
Carrier power	10, 20, 25, 35 W / 50 ohm		
Adjacent Channel Power	According to EN 55022 and FCC CFR47 part 90		
Carrier power stability	+ 2 dB / - 3 dB		

	DATA MODEM	
Timing	RS-232	
Electrical Interface	RS-232	
Interface Connector	8-pin LEMO HGA. 1B. 308. CLPP	
Data speed of I/O-interface	300 – 38400 bps	
Data speed of Radio Interface	19200 bps (25 kHz channel) / 9600 bps (12.5 kHz channel)	
Data Formats	Asynchronous RS-232	
Modulation	4FSK, GMSK, (PacificCrest, TRIMTALK **)	

\*\*) TRIMTALK is a trademark of Trimble Navigation Ltd.

	GENERAL	
DC input ranges	Nominal voltage : +9...+16 V <sub>DC</sub>	4-pin ODU MINI-Snap Size 1
Temperature Ranges	-25 °C...+55 °C	Complies with standards
	-40 °C...+75 °C (absolute min / max)	Functional
	-40 °C... +85°C	Storage
Antenna Connector	TNC, 50 ohm, female	
Construction	Aluminium housing	
Size L x W x T	165 x 138 x 73 mm	
Weight	1640 g	
IP Classification	IP67 (NEMA 6)	

	OTHER MEASUREMENTS	
ESD-failure threshold	8 kV contact, 15 kV air discharge	
Immunity test	10V/m	

### Note 1

Due to radio electronic design, the receiver is about 6 – 15 dB less sensitive on the following frequencies:

403.000, 416.000, 429.000, 442.000, 455.000, 468.000, 409.5875 and 469.200 MHz.

\*) If high output power is used continuously or with a high cycle, the equipment generates excess heat. The output power is automatically decreased when necessary to prevent overheating. Typical operating times are shown in the chart with different output powers and duty cycles @ 22°C and 35 °C (see page 16).

## 1.1 Default settings

SATELLINE-EASy Pro 35W is shipped with the following default settings (unless otherwise specifically agreed):

DEFAULT VALUES OF THE ADJUSTABLE SETTINGS (user can change settings later on)		
Setting	Default value	Range
<b>Radio frequency</b>		
Operating TX frequency	438.000 MHz	Range: 403 - 473 MHz
Operating RX frequency	438.000 MHz	Range: 403 - 473 MHz
Reference Frequency	438.000 MHz	Range: 403 - 473 MHz
Channel Spacing	12.5 kHz	Range: 12.5, 20 or 25 kHz
<b>Radio settings</b>		
Tx Power	35 W	Range: 10, 20, 25 and 35 W
Signal threshold	-115 dBm	-80 ... -118 dBm
FCS	OFF	ON/OFF
Tx-Start Delay	0 ms	0-65535 ms
Radio Compatibility	SATEL 3AS	SATEL 3AS, Option1=PCC 4-FSK, Option 2=PCC GMSK, 3=TrimTalk
<b>Addressing</b>		
RX Address	OFF	ON/OFF
TX Address	OFF	ON/OFF
RX addressing to RS port	OFF	ON/OFF
TX address auto switch	OFF	ON/OFF
<b>Serial port 1</b>		
Status	ON	ON/OFF
Interface	RS-232	Fixed
Data speed	9600 bps	300, 600, 1200, 2400, 4800, 9600, 19200, 38400 bps
Data bits	8	7, 8, 9
Parity bits	None	None, Even, Odd
Stop bits	1	1, 2
<b>Handshaking</b>		
CTS	Clear to send	Clear to send, TX buffer state
CD	RSSI threshold	RSSI- threshold, Data on channel, Always ON
RTS	Ignored	Ignored, Flow Control, Reception Control
Pause length	3 bytes	3 ... 255 bytes
<b>Additional setup</b>		
Error correction	OFF	ON/OFF
Error check	OFF	ON/OFF
Repeater	OFF	ON/OFF
SL-commands	ON	ON/OFF
Priority	TX	RX/TX
FullCR16 Check	OFF	ON/OFF
<b>Routing</b>		
Routing	OFF	ON/OFF
<b>Tests</b>		
Tests	OFF	ON/OFF

The power cable (+V<sub>b</sub> and GND) must be connected to a power supply with a proper output voltage (+9...+16 V<sub>DC</sub>) and with a minimum output current of 15A.

When creating a test connection, you can use Windows™ based SATEL Configuration Manager (available for free from authorised SATEL dealers or directly from SATEL Customer Support), HyperTerminal (which is included in most the Windows™ based operating system packages), or almost any other terminal program.

Basic settings for the serial port of the host computer, when using a terminal program to communicate with SATEL radio modems, are as follows: "COM1, 9600 bps, 8-bit data, none parity, 1 stop bit".

If the serial port designated as COM1 in the host computer is reserved, any other free serial port in the host computer can be used (with the settings listed).

Note: If you want to change the settings of a radio modem using the *Programming Mode* of the radio modem with the help of an external terminal, the data speed of the terminal must be 9600 bps.

## 2 OTHER FEATURES

SATELLINE-EASy Pro 35W radio modem fulfils the IP67 (NEMA 6) standard. With an IP67 rating a product will be totally protected against dust and remain completely sealed when immersed in water to a depth between 15 cm and 1 meter.

SATELLINE-EASy Pro 35W modem is equipped with a high power 35 W transmitter. It is designed for easy mobile use in demanding field conditions.

The SATELLINE-EASy Pro 35W is equipped with a liquid crystal display (LCD) and a keypad, used to indicate the current operating status, as well as for changing the operating channel and power level of the radio modem.

## 3 SATELLINE-EASy Pro 35W SPECIAL FEATURES

### 3.1 Call Sign

SATELLINE-EASy Pro 35W has a CALL SIGN identifier -feature required in some countries. A call sign can be formally assigned by a government agency, informally adopted by individuals or organizations, or even cryptographically encoded to disguise identity of a station.

A call sign is an FCC (in US) or other regulatory authority assigned identifier that is issued along with the license for operating a radio modem. This field is for entering your call sign. The modem automatically broadcasts the specified call sign periodically. If this field is empty, there is no call sign information.

Call sign setup can be found in PROG-menu clause *Radio settings* and further in its sub clause *Call sign*. Call sign has three (3) different setups. With **Call sign mode** you can set Morse code transmission ON or OFF. **Call sign ID** defines which Morse code will be transmitted. Only capital letters and numbers are allowed. If the digits are wrong kind, there will be message: *Value error*. Small letters will be converted to capital letters automatically. If **Call sign ID** field remains empty, the Call Sign transmission will not be activated. **Call sign timer** is the transmission delay of Morse codes. Minimum and default transmission time is 15 minute.

During Call sign transmission the CTS-line of the modem is not in active state. This is to inform terminal equipment that the modem is not ready to neither receive data from serial port nor forward it. The modem deletes all data (also SL commands), which has arrived to serial port during call sign transmission. Call sign transmission lasts 1-4 seconds depending on the number of digits.

### 3.2 Temperature protection of RF power amplifier

RF power amplifier is protected against overheating. The power of transmitter is lowered step by step if the inner temperature exceeds certain levels as shown below.

Temperature inside a modem	Carrier power
Over 75°C	25 W
80°C	20 W
85°C	10 W
90°C	0 W (transmitter OFF)

When the ambient temperature is under 30°C and transmitter duty cycle does not exceed 40%, the temperature inside the modem does not exceed the trigger level.

The internal temperature is measured in the beginning of every transmission and at once when modem cools down. The carrier power increases with falling temperature so that at 88°C carrier power goes to 10W, at 83°C to 20W, at 78°C to 25W and at 73°C the modem operates again at the full 35W carrier power.

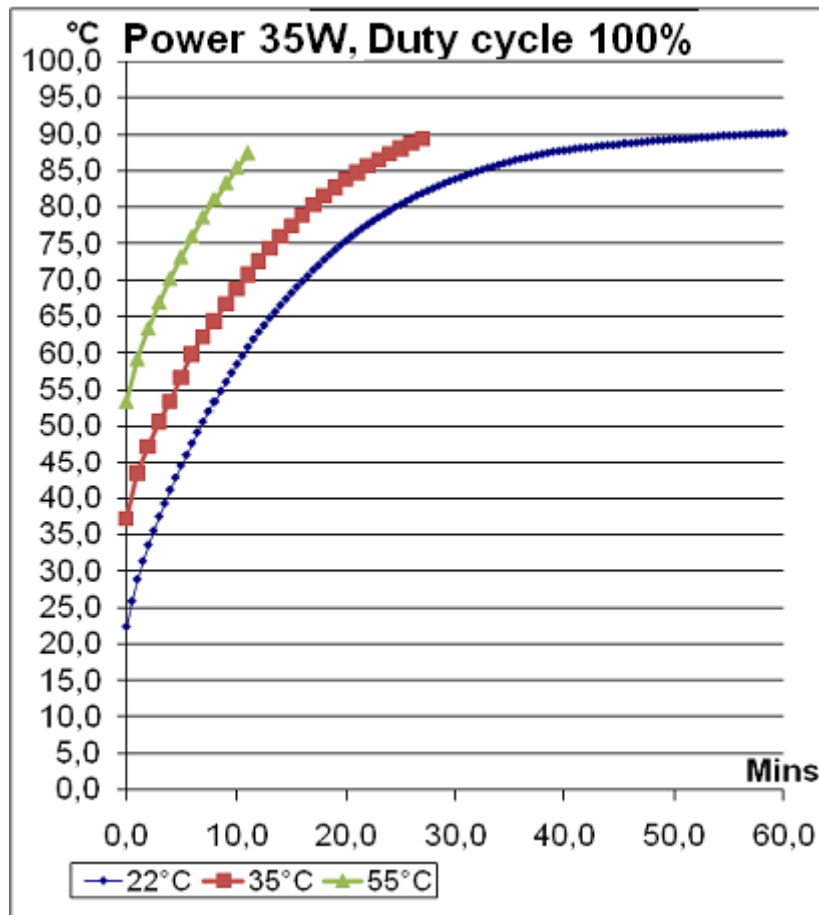

### **3.3 Protection of current**

In case of bad antenna impedance matching the current consumption of the Power Amplifier may be too high. For this reason the maximum PA current is limited to 12 A. If current tends to increase over 12 A, automatic gain control circuits decrease power level of a modem until current drops under 11.5 A. New transmission starts always with max power level. The ballast can be seen in LDC-display. If display blinks, ballast is on. If it does not blink, display shows the normal power level. Power is reduced only at the 35 W power level and never more than 2 dB.

## 4 SERIAL INTERFACE

The radio modem is referred to as DCE (Data Communication Equipment) whereas the PC is referred to as DTE (Data Terminal Equipment). SATELLINE-EASy Pro 35W includes a 8 pin LEMO HGA which contains all the connections required to establish communication between the radio modem, acting as the DCE, and the PC, acting as the DTE.

All EMC-requirements set forth by authorities have been taken into account in the design of the radio modem. The radio modem user is thereby not required to take any special actions regarding EMC-shielding (of the radio modem).

The radio modem has one serial port, **Port 1** which complies with the RS-232 standard.

Signal	8-pin LEMO
RD	4
TD	5
CTS	2
RTS	1
GND	3
MODE	6

### Description of pins:

- *RD* = **R**eceive **D**ata. Output of the data received from the radio modem to the DTE.
- *TD* = **T**ransmit **D**ata. Input of the data to be transmitted from the DTE to the radio modem.
- *CTS* = **C**lear **T**o **S**end.
- *CD* = **C**arrier **D**etect.
- *RTS* = **R**equest **T**o **S**end.
- *MODE* = operational mode. When the *MODE*-line is connected to ground (*GND*), the radio modem enters the *Programming Mode*, which is used to change the settings of the radio modem (i.e. configuration, set-up). If the *MODE*-line is not connected, the radio modem will enter the *Data Transfer Mode*, in which data can be transmitted and received. The *Programming Mode* is used only when installing a radio modem and changing the operational parameters of a network. Normally the radio modem is always in the *Data Transfer Mode*.
- *GND* = both the negative pole of the operating voltage and the signal ground.

## 5 USER INTERFACE

### 5.1 LED-indicators

There are five (5) LED indicators on the front panel of the radio modem, and they give an indication of the status of the serial port and the radio interface:

Description of the LED-indicators:



LED	Indication	OFF	Red	Orange	Green
RTS	RTS-line status	Inactive	Active		
CTS	CTS-line status	Inactive	Active		
TD	TD-line status	No data	Data		Test Tx active
RD	RD-line status	No data	Data		
CD	Radio status	No signal	Transmission	Noise	Reception

### 5.2 Display and push buttons

SATELLINE-EASy Pro 35W includes a LCD-display with a backlight. In the *Data Transfer Mode* the display will show the operating settings of the radio modem, for example the radio field strength and the supply voltage. By using the push buttons and the LCD-display, it is possible to change most of the settings of the radio modem, without the need for an external terminal. The display backlight illuminates automatically as soon as a button is pressed.

The radio modem will shift into the *Programming Mode* by pressing the SETUP-push button (■). When activated the menu shows a listing of the changeable parameters.

With the help of the main menu, sub-menus can be selected which in turn can be used to change the settings. You can always return to the previous higher level of the menu structure by pressing the CANCEL (or BACK) push button. Pressing the ▲ or ▼ button changes settings or moves in the menu. Selections are confirmed by pressing the SELECT or SET button. In case of numerical values the digit to be changed is selected by pressing the NEXT button (see following page).

### 5.2.1 SATELLINE-EASy Pro 35W LCD-display after power-up

The display shows the basic information which is revolving automatically in 5 seconds.

#### Display in Data Transfer Mode (transmit/receive mode)

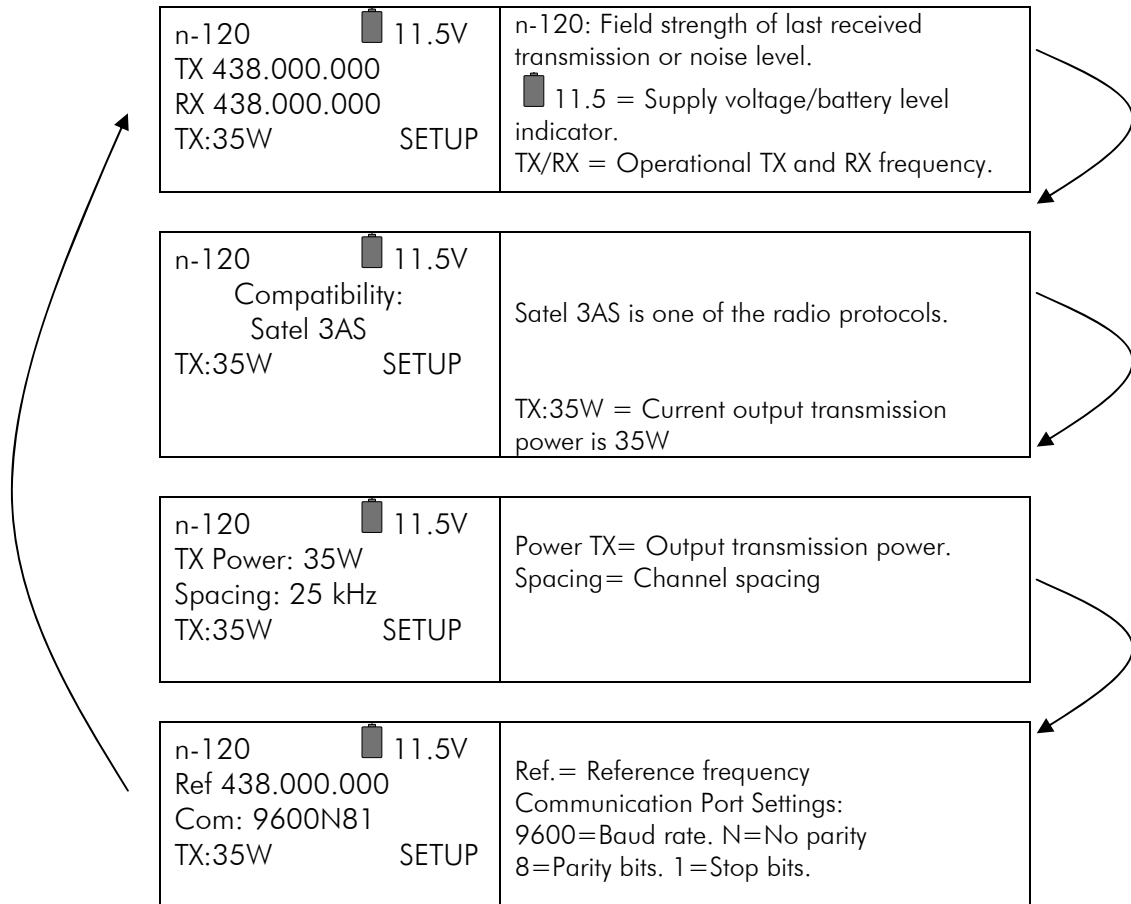

#### INFO - SETUP

By pressing cancel/back button the modem goes to detailed information about the modem's settings.

By pressing SETUP the modem goes to the programming menu.

**Display in Info mode.**

Pressing ▲ ▼ shows the next window.

EASy-35W S/N: FW:06.18.3.44 Exit ▼	Product name Serial number FW: Firmware version
TX 438.000.000 RX 438.000.000 Ref 438.000.000 Exit ▲ ▼	TX frequency RX frequency Reference frequency
Band 1 limits Lo 403.000.000 Hi 473.000.000 Exit ▲ ▼	The modem can be limited to operate only on certain frequencies. The range is shown as LO=Low and HI=High.
Band 2 limits Lo 403.000.000 Hi 473.000.000 Exit ▲ ▼	The modem can be limited to operate only on certain frequencies. The range is shown as LO=Low and HI=High.
Voltage: 9-16V Port 1:RS232/ON Exit ▲ ▼	Voltage: Operation Voltage range. Port1: Port interface and status.
Board: SPL0005d +EPT IM:05 Exit ▲	Board: HW version  IM: Interface module type

**Display in Setup Mode**

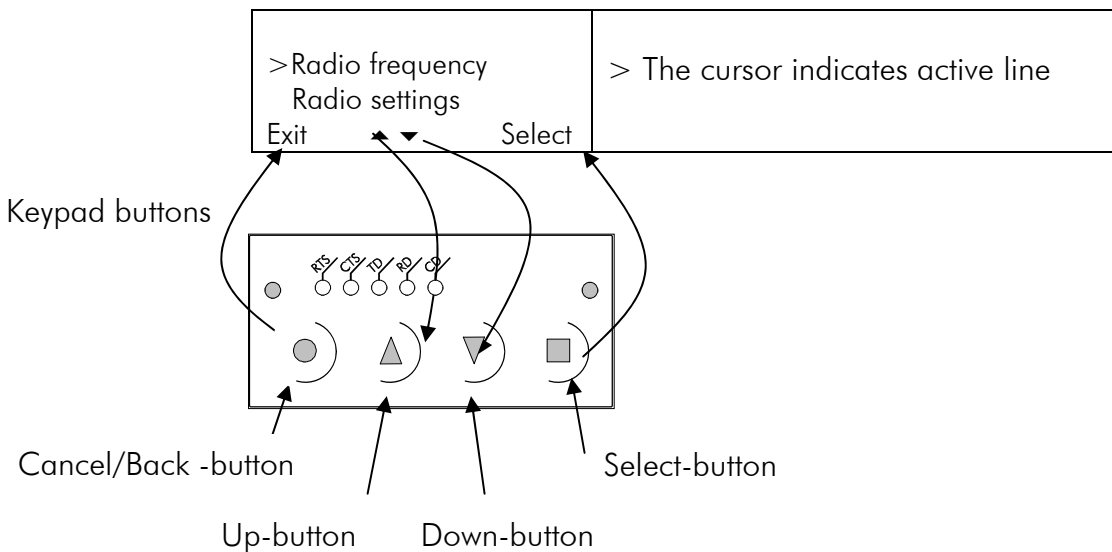

## 6 CONNECTION INTERFACES

### NOTE!

When installing the cables of the serial interface, it is recommended that the operating voltage of all devices is powered OFF.

### 6.1 RS-232 interface

RS-232 standard defines the method of serial data transfer between a computer and its peripherals. The definition includes both the interface type and signal levels. Most computers and peripherals contain one or more RS-232 type serial ports. The RS-232 standard uses transmission lines, in which each single signal line level is referenced, to a common ground level. RS-232 has been designed to be use in serial transfer of data, in situations where the distance between communicating equipment is less than 15 m. The otherwise useful RS-232 standard is applied in a multitude of slightly differing ways, (e.g. different pin configurations) and for this reason different computers and peripherals are not necessarily directly compatible with each other.

### 6.2 Connectors

The device adopts a high standard waterproof Lemo 8-pin data connector. Antenna connector type is 50 Ohm TNC female.

#### 1. Data connector

8 pin LEMO HGA. 1B. 308. CLPP

1	RTS
2	CTS
3	SGND
4	RXD
5	TXD
6	PROG
7	Not connected
8	Not connected

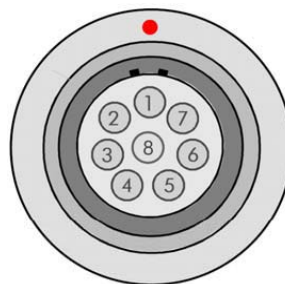

#### 2. Power connector

4 pin ODU MINI-SNAP Style G4 size 1

1	PWR (+)
2	PWR (+)
3	GND
4	GND

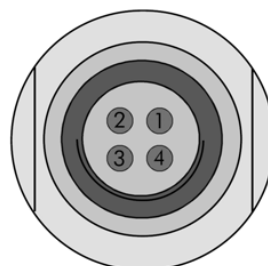

## 7 RF INTERFACE

The SATELLINE-EASy Pro 35W has a single TNC type RF-connector with impedance of 50 Ohm. When the modem, is supplied the frequency is set to "default channel". The user can change the frequency afterwards by 70 MHz. Of course, all local regulations set forth by the authorities must be taken into consideration.

The data speed of the radio interface is set to "default speed". It can also be set afterwards. A channel spacing of 25 kHz enables a data speed of 19200 bps and a channel spacing of 12.5 / 20 kHz enables, correspondingly, a data speed of 9600 bps. The data speed of the radio interface is always fixed (19200 bps or 9600 bps) irrespective of the data speed of the serial interface. If the data speeds of the radio interface and the serial interface differ from each other, the radio modem will buffer the data in transfer temporarily, so no data loss will occur.

### 7.1 Transmitter

The output power of the transmitter is adjustable. The greatest allowable power depends on limits set by local authorities, which should not be exceeded under any circumstances. The output power of the transmitter should be set to the smallest possible level, which still ensures error free connections under variable conditions. Large output power levels using short connection distances can, in the worst case, cause disturbances to the overall operation of the system.

OUTPUT POWER	dBm
10 W	+40
20 W	+43
25 W	+44
35 W	+45,4

Possible output power settings.

#### **NOTE!**

Setting the radio data modem output power level to that which exceeds the regulations set forth by local authorities is strictly forbidden. The setting and/or using of non-approved power levels may lead to prosecution. SATEL and its distributors are not responsible for any illegal use of its radio equipment, and are not responsible in any way of any claims or penalties arising from the operation of its radio equipment in ways contradictory to local regulations and/or requirements and/or laws.

## 7.2 Receiver

The sensitivity of the receiver depends on the channel spacing of the radio modem (=data speed of the radio interface) and on the mode of the FEC (error correction) according to the table below:

Channel spacing	FEC OFF	FEC ON
25 kHz	-108 dBm	-111 dBm
20 kHz	-111 dBm	-114 dBm
12.5 kHz	-111 dBm	-114 dBm

The Signal Threshold Level setting of the receiver determines a level, above which the search for the actual data transfer signal is active. It is recommended that values given in the table are used. If the Signal Threshold Level setting is set too low (the CD-LED is ON constantly), it is possible that the receiver is trying to synchronise itself with noise, in which case, the actual data transmission might remain unnoticed. Alternatively, weak data transmissions will be rejected, even though they would be otherwise acceptable.

## 7.3 Priority RX/TX

SATELLINE-EASy Pro 35W offers a *Priority* setting, which selects the priority between reception and transmission. The setting can be changed in *Programming Mode*. By default, transmission has higher priority than reception i.e. the default value is Priority TX.

*Priority TX* means that a terminal device attached to a radio modem decides the timing of the transmission. The transmitter is immediately switched on when the terminal device starts to output data. Should reception be in progress, the radio modem will stop it and change to a transmit state. There is no need to use any handshaking for the control of timing.

*Priority RX* means, that a radio modem tries to receive all data currently in the air. If a terminal outputs data to be transmitted (or an SL command) it will be buffered. The radio modem will wait until the reception has stopped before transmitting the buffered data. This will result in timing slacks to the system, but decreases the number of collisions on the air; this is particularly useful in systems based on multiple random accesses.

To toggle the *Priority* setting in the programming menu, select:

1) Priority RX / TX

If the Repeater Function has been set on, priority setting is automatically switched to RX mode.

## **7.4 Forward Error Correction**

Forward Error Correction, FEC-function is switched ON (or OFF) by using the *Programming Mode*. When activated, the FEC-function will cause the SATELLINE-EASy Pro 35W to automatically add additional error correction information, which increases the amount of transmitted data by 30 %. It is used by the receiving radio modem to correct erroneous bits - as long as the ratio of correct and erroneous bits is reasonable.

Error correction improves the reliability of data transfer via the radio interface especially in unfavourable conditions. FEC-function should be used when link distances are long and/or if there are many disturbances in the radio channels used. The use of the FEC-function will, however decrease the data transfer throughput of data by about 30 %. The list of exact delays when using FEC-function, are introduced in appendix B.

To switch the FEC-function ON in the *Programming Mode*, select:

1) Error correction ON

### **NOTE!**

All radio modems, which are to communicate with each other, must have the same setting for FEC (ON or OFF). If the transmitting radio modem and the receiving radio modem has different settings, data will not be received correctly.

## **7.5 Error checking**

When the error checking is switched on, the radio modem will add a checksum to the transmitted data. When the data is received, the checksums are verified before data is forwarded to the serial port. There are two different options for error checking that can be accessed in the Additional setup menu in the *Programming Mode*:

2) Error check

6) Full CRC16 check

*Error check* checks data partially while data is received.

*Full CRC16 check* function adds two checksum characters at the end of the user data message. At the reception end the receiver receives first the whole package and if the checksum matches the data message is forwarded to the serial port. If *Full CRC16 check* is selected it must be set ON for all radio modems in the same network. Otherwise the checksum characters appear at the end of user message on the serial port.

## **7.6 Dual radio function, separate RX/TX-frequencies**

The SATELLINE-EASy Pro 35W can transmit (TX-frequency) and receive (RX-frequency) on separate frequencies. Separate frequencies can be set within the whole tuning range. The frequencies can be set in the display menu, in the programming mode or by the Configuration Manager.

When data flow on the TD line starts the frequency shifts from the receiving channel to the transmit channel. There is a 40 ms delay caused by the frequency shift before the actual data transmission sequence starts, and the same time is needed for the return to the receive channel after transmission.

The selected channel spacing, port settings etc. are equal to both frequencies.  
The dual radio settings can be adjusted also by the SL commands.

## 7.7 Free Channel Scan (FCS)

Free Channel Scan (FCS) is designed for one-way transmission between one transmitter and one or more receivers when there are at least two different radio frequencies available. The transmitter monitors the noise level of the channels between the transmissions and finds the best transmission channel. The receivers scan and follow the frequency of that particular transmitter consequently. The feature is beneficial e.g. for the applications in land surveying or when license free channels are used and there could be other transmitters using the same channels.

To make the use easier SATEL provides the FCS terminal software for your PC. Using the program it is easy to configure the radio modems to use the FCS function. There is also a scanning tool for measuring the power level of the selected radio channels. A more detailed description of FCS function and FCS terminal software is available from the manufacturer or from the nearest distributor.

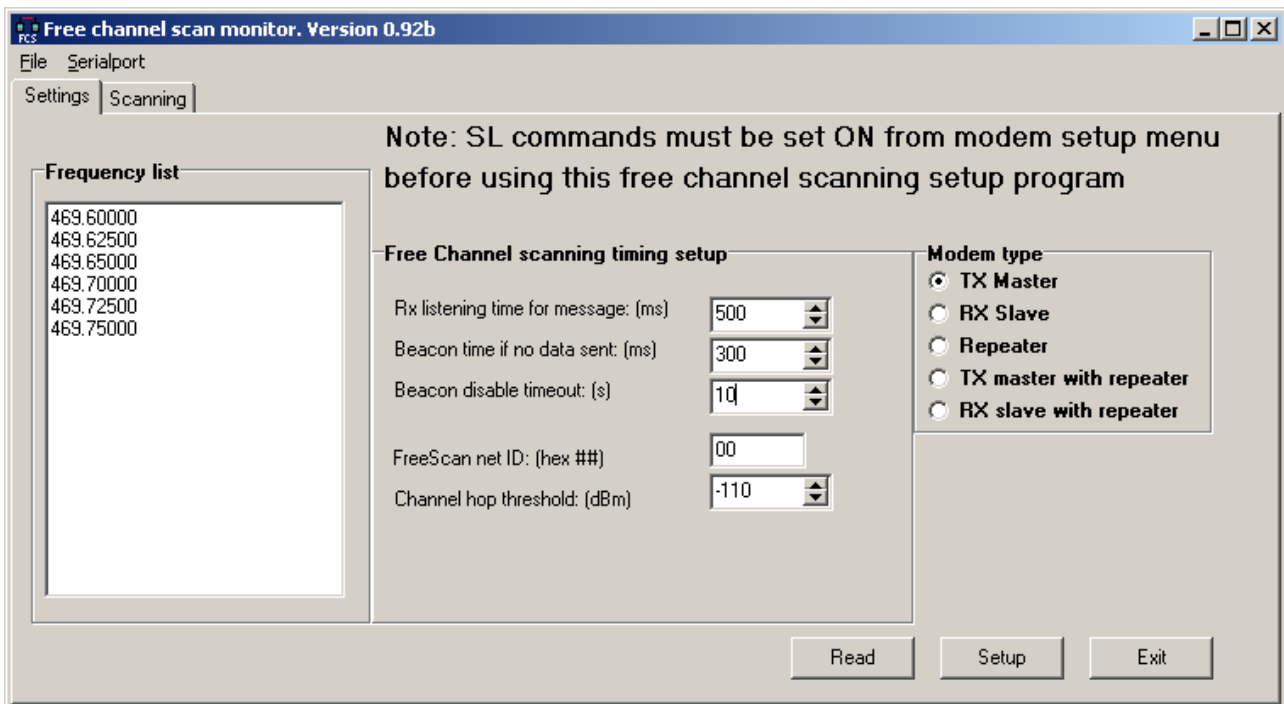

A screen snapshot of the FCS terminal software

## **7.8 User data whitening**

In some cases, if the user data includes a large number of constant characters, additional bit errors may appear. The use of error correction (FEC) is recommended in such cases. If that is not possible, the Data whitening feature can be used to improve the reliability of data transfer. The feature is set on/off in the programming mode.

**NOTE!**

All radio modems, which are to communicate with each other, must have the same setting for Data whitening (ON or OFF). If the transmitting radio modem and the receiving radio modem has different settings, data will not be received correctly.

## 8 TRANSPARENT DATA TRANSMISSION

### 8.1 Serial interface, data format

The SATELLINE-EASy Pro 35W serial interface uses an asynchronous data format. No external synchronising signal is needed, since necessary timing information is acquired from the start and stop bits transmitted before and after each data field bits (byte).

The data transfer speed of the serial interfaces can be set to 300, 600, 1200, 2400, 4800, 9600, 19200 or 38400 bps (bits per second). The length of the data field must be 7, 8 or 9 bits. When using a data field length of 7 or 8 bits, a parity bit may also be used.

One character to be transmitted will thus contain a start bit; the data bits (which define the specific character in question); an optional parity bit and one or two stop bits. The overall length of one character is therefore 10, 11 or 12 bits. This should be taken into account when calculating the data throughput capability of a system. In other words, the number of start, stop and parity bits must be considered. A useful rule of thumb is that at a data transfer speed of 9600 bps, the transmission of one character will require roughly one millisecond (1 ms).

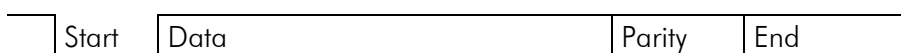

Asynchronous character data format

**Example:** With an 8-bit data character length and taking, for example, a decimal value of "204", (which corresponds to a binary value of "11001100") and with a start bit value of "0", parity bit set to either "NO" (NONE), "0" or "1" and with a stop bit value of "1", the possible combinations are listed in the table below:

DATA FORMAT	CHARACTER	CHARACTER LENGTH
8 bit, no parity, 1 stop bit	0110011001	10 bit
8 bit, even parity, 1 stop bit	01100110001	11 bit
8 bit, odd parity, 1 stop bit	01100110011	11 bit
8 bit, no parity, 2 stop bits	01100110011	11 bit
8 bit, even parity, 2 stop bits	011001100011	12 bit
8 bit, odd parity, 2 stop bits	011001100111	12 bit

If the settings of data speed, character length, parity or the number of stop bits differ between the radio modem and the terminal, errors will be introduced into the transferred data. The serial port settings of each individual radio modem in a system can all be different apart from the data length setting (7, 8 or 9 bits), which must always be the same in each individual radio data modem. In other words, the serial port used, the data transfer speed, parity and number of stop bits; can be different in different parts of a same system. This is especially useful where one part of the system uses an RS-485 serial port and another part uses the RS-232 serial port. In other words, radio modems may also be utilised as serial port adapters in addition to the more common role of wireless data transfer. The serial port settings can be changed in the *Programming Mode*.

## 8.2 Handshake lines

When using the RS-232 serial interface, handshake signals can be used to control data transfer. Handshake signals are used, for example, by the radio modem to inform the terminal that the radio channel is busy, and that it cannot initiate transmission. The terminal can also control the radio modem via RTS-line.

Line	Direction
CTS	To terminal
RTS	To modem
CD	To terminal

A common way of using handshaking signals is to monitor the CTS-line and ignore the others. Usually the terminal is fast enough to handle the data received by the radio modem, so the use of RTS-line is not necessary.

Handshaking is not needed if the system protocol is designed to prevent collisions (data contention) by the use of polling, or if there is little traffic and also if there is no harm from occasional data contention situations (several radio modems try to transmit at the same time).

### 8.2.1 CTS-line

The options for CTS-line are:

#### 1) **Clear To Send**

CTS is active when the radio modem is ready to accept data for new transmission. CTS will shift into inactive state during data reception and transmission.

#### 2) **TX buffer state**

CTS will shift into inactive state only if the radio modem's TX buffer is in danger of overflowing. This typically happens when the serial interface data transfer speed is greater than the radio interface transfer speed and the size of transmitted messages is large. CTS is connected to pin 2.

### 8.2.2 CD-line

The options for CD-line are:

#### 1) **RSSI-threshold**

CD is active whenever a signal with a level exceeding the level required for reception exists on the radio channel. It doesn't make any difference if the signal is an actual data transmission, a signal of a radio transmitter not belonging to the system, or even an interference signal caused for example, by a computer or a peripheral device. CD is also active when the radio modem in question is transmitting.

## 2) Data on channel

CD will switch to active state only after recognition of a valid data transmission. CD will not react to interference signals.

## 3) Always ON

CD is always in the active state. This option can be used with terminal equipment, which use the CD-line as an indicator of an active connection (the radio modem can transmit and receive at any time).

### **8.2.3 RTS-line**

The options for RTS-line are:

#### 1) Ignored

RTS-line status is ignored.

#### 2) Flow control

The radio modem transmits data to the terminal device only when the RTS-line is active. Non-active state of the RTS-line will force the radio modem to buffer the received data. This option is used if the terminal device is too slow to handle data received from the radio modem.

#### 3) Reception control

RTS-line controls the reception process of the radio modem. An active RTS-line enables reception (as normal). Non-active RTS-line will interrupt reception process immediately, even if the radio modem is receiving a data packet. This option is used to force the radio modem into WAIT State for an immediate channel change.

## **8.3 Timing and delays during data transmission**

When using a radio modem for data transmission, certain delays will be formed through the use of a radio interface and from the radio modem circuitry itself. These delays exist when the radio modem switches from *Standby Mode* to *Data Transfer Mode* and during reception and transmission of data. For detailed delay values in each case see Appendix B.

### **8.3.1 Data buffering in the radio data modem**

Whenever the radio modem is in *Data Transfer Mode* it monitors both the radio channel and the serial interface. When the terminal device starts data transmission the radio modem switches to transmission mode. At the beginning of each transmission a synchronisation signal is transmitted and this signal is detected by another radio modem, which then switches into receive mode. During the transmission of the synchronisation signal the radio modem buffers data into its memory. Transmission ends when a pause is detected in the data sent by the terminal device, and after all buffered data has been transmitted. When the serial interface speed is the same or slower than the speed of the radio interface, the internal transmit buffer memory cannot overflow.

However, when the serial interface speed exceeds the speed of the radio interface, data will eventually fill transmit buffer memory. In this instance, it will take a moment after the terminal device has stopped transmission of data for the radio modem to empty the buffer and before the transmitter switches off. The maximum size of transmit buffer memory is one kilobyte (1 kB). If the terminal device does not follow the status of the CTS-line and transmits too much data to the radio modem, the buffer will be emptied and the transmission is restarted.

In the receive mode, the buffer works principally in the above described way thus evening out differences in data transfer speeds. If the terminal device transmits data to a radio modem in receive mode, the data will go into transmit buffer memory. Transmission will start immediately when the radio channel is available.

### **8.3.2 Pause length**

The modem recognises a pause on the serial line (a pause is defined as a time with no status changes on the RS-232 interface TD-line). The pause detection is used as criteria for:

- o End of radio transmission - When the transmit buffer is empty and a pause is detected, the modem stops the transmission and will then change the radio to the receive mode.
- o SL-command recognition - For a SL-command to be valid, a pause must be detected before the actual "SL..." character string.
- o User address recognition - In order for the start character to be detected, a pause must precede it in transmission.

Traditionally, in asynchronous data communication, pauses have been used to separate serial messages from each other. However, the use of non-real-time operating systems (frequently used on PC-type hardware) often adds random pauses, which may result in the user data splitting into two or more separate RF transmissions. This may cause problems especially in the systems including repeater stations.

In order to match the operation of the radio modem to the user data, the Pause length parameter can be adjusted on the programming menu. It may have any value between 3 and 255 characters. The default value is 3 characters.

Notes:

- o The absolute time of Pause length is depending on the serial port settings. For example, 1 character is ~1.04 ms at 9600 bps / 8N1 (10 bits).
- o The maximum absolute time is always 170 ms independent from the value of the Pause length given in the set-up.
- o An increase in the Pause length increases the round trip delay of the radio link correspondingly; this is due to the fact that the radio channel is occupied for the time of the Pause length after each transmission (the time it takes to detect a pause). If this is not acceptable, the TX delay setting may also be useful in special cases.

### **8.3.3 TX delay**

The radio modem can be configured to delay the beginning of a radio transmission by 1...65000 ms. This function can be used to prevent packet contention in a system, where all substations would otherwise answer a poll of a base-station simultaneously. During this delay data sent to the radio modem is buffered. Although the priority setting is "RX", radio modem is prevented to change over to receiving mode during the period of the TX delay. If this function is not needed, the delay time should be set to 0 ms.

## **8.4 Testing**

The radio modem can be switched to the *Test Mode*, where it will send a test packet on the radio channel. The test packet is a normal data transmission, which can be used, for example, when directing antennas during system installation.

When the test packet transmission has been switched on and saved by using the *Programming Mode*, the transmitting radio modem needs only a power supply and an antenna.

If the channel spacing of the radio modems is 25 kHz, it is recommended to use 38400 bps as a serial data speed of the receiving radio modem. In the case of 12.5 / 20 kHz channel spacing the data speed of 19200 bps is recommended.

There are two *Test Modes*:

### **Short data block test**

In this test mode the radio modem sends a short test string, which is preceded by a consecutive number, and it ends to the line feed character. The short data block is repeated continuously after 1 s break.

Short data block test is suitable for running data communication tests. Error-free reception of data can be monitored using a suitable terminal program.

### **Example of a short data blocks:**

```
00 This is a testline of SATELLINE-3AS radio modem
```

### **Long data block test**

Long data block consists of character strings, which are repeated without breaks 50 s time period. After 10 s break the test transmission is started again.

Long block data test can be used for measuring Tx output power, standing wave ratio (SWR) of the antenna system or received signal strength at Rx stations.

### **Example of a long data blocks:**

```
00 This is a long testline of SATELLINE-3AS radio modem
```

The strength of the received signal can be monitored using the LCD-display of the receiving radio modem.

**NOTE 1!** Green TD led indicates active test mode.

**NOTE 2!** Normal data transfer is not available while the Test mode is active. Remember to switch it OFF before starting the normal data transfer.

**NOTE 3!** Message Routing and FCS mode must be disabled prior to set ON the Test mode.

## 9 SETTINGS

The configuration of SATELLINE-EASy Pro 35W can be easily changed. Simply by connecting MODE pin (see chapter 6.2) of the data connector to ground (GND) the radio modem will switch into Programming Mode. Serial **PORT 1** is used whenever the radio modem is in the *Programming Mode*. The serial port settings are 9600 bps, N, 8,1 (data transfer speed 9600 bps, no parity, character length 8 bits and one (1) stop bit).

SATELLINE-EASy Pro 35W contains push buttons and a LCD-display, which can be used to modify configuration settings without the help of an external terminal device. The radio modem will switch into *Programming Mode* by pressing the "SETUP" ( ■ )button.

If the SL-command function has been activated active radio channel and addresses etc. can be changed without switching the radio modem into *Programming Mode*. Serial port settings will remain as those defined previously when the radio modem was in *Programming Mode*.

### 9.1 Programming Mode

The settings of SATELLINE-EASy Pro 35W are fully configurable in Programming Mode by using a suitable terminal program. The most recommendable set-up is NARS-1F interface adapter (please note that power is supplied with C-P-35W), NARS-ST or NARS-35W (depending on data connector at the radio modem) cable, power cable C-P-35W, a power supply and terminal program such as or SaTerm. NARS-1F contains a switch to enable easy shifting into the Programming Mode. SATEL Configuration Manager or other suitable terminal programs and cables may also be used.

The radio modem will shift into the Programming Mode by connecting MODE pin (see chapter 6.2) of the data connector to ground (GND). When using the NARS-1F, this can be accomplished by moving the slide switch towards D-9.

In the *Programming Mode*, the radio modem is forced to use serial **PORT1**, with settings 9600 bps, N, 8,1 (data transfer speed 9600 bps, no parity, 8 data bits and 1 stop bit).

## 9.2 Changing parameters using a terminal device

### 9.2.1 Changing the settings

- o Connect cables (RS-232 cable to PC COM-port, power supply cable to power supply).
- o Switch on the PC and start the terminal program.
- o Open a terminal window and then choose "Pr" (in case you are using some other terminal program, set the serial port parameters of the program as follows: 9600 bits/s, 8 data bits, no parity, 1 stop bit, which is always the default in *Programming Mode*).
- o Connect PROG-pin to ground (if using the NARS-1F adapter, slide the switch downwards), the radio modem shifts now into the *Programming Mode*. The screen should look similar to the one shown in the picture below.
- o Make desired changes to the settings.
- o Save changes by pressing "E" in the main menu. If you don't want to save changes, press "Q".
- o Disconnect PROG-pin from ground (if using the NARS-1F adapter, slide the switch upwards), the radio modem should now return to the *Data Transfer Mode*.

```
***** SATELLINE *****
FW: 06.18.x.xx / HW: SPL0005d+EPT / PV: 05.00 / IM: 05 / S/N: YYMMxxxxx
-----
Current settings
-----
1) Radio frequency TX: 438.0000 MHz / RX: 438.0000 MHz /
Ref freq: 438.0000 MHz / Spacing 25 kHz
2) Radio settings Tx power 35W / Signal threshold -115 dBm / FCS OFF /
TX start delay 0 ms / Compatibility Satel 3AS / Call sign OFF
3) Addressing RX address OFF / TX address OFF /
RX address to RS port OFF / TX address autoswitch OFF
4) Serial port 1 ON / 9600 bit/s / 8 bit data / None parity /
1 stop bit
5) Serial port 2 OFF / 9600 bit/s / 8 bit data / None parity /
1 stop bit (TTL)
6) Handshaking CTS Clear to send / CD RSSI-threshold /
RTS Ignored / Pause length 3 bytes
7) Additional setup Error correction OFF / Error check OFF / Repeater OFF /
SL-commands ON / Priority TX / Full CRC16 check OFF /
User Data whitening OFF
8) Routing OFF
9) Tests OFF
A) Restore factory settings
B) INFO
E) EXIT and save settings
Q) QUIT without saving

Enter selection >
```

## 9.2.2 Restoring factory settings

The settings that the modem was delivered from the factory are called “factory settings”.

“Restore factory settings” selection is achieved by selecting “A” from the menu list. Factory settings are restored by selecting “Y” (YES). By pressing “N” (NO) or any other button no changes is done and current settings will remain active. The modem will ask this question twice to make ensure that this is a valid command.

```
Enter selection >A
Restore factory settings
-----
Do you want to restore factory settings? (Y/N)>
```

**PORT 1** of the radio modem is connected to a terminal device or a PC, which is in terminal emulation state. (This can be accomplished by using a suitable program such as the *SaTerm* program or the Windows™ Hyper Terminal program). Check the wiring of the serial port connection cable. Terminal device serial port settings must be set to 9600 bps, N, 8, 1 (data transfer speed 9600 bps, no parity, data length 8 bits and one (1) stop bit). MODE-pin (see chapter 6.2) is then connected to ground (GND). Following this the radio modem will transmit the following message to the terminal (certain configuration settings might differ from the ones shown):

```
***** SATELLINE *****
FW: 06.18.x.xx / HW: SPL0005d+EPT / PV: 05.00 / IM: 05 / S/N: YYMMxxxx
-----
Current settings
-----
1) Radio frequency TX: 438.0000 MHz / RX: 438.0000 MHz /
Ref freq: 438.0000 MHz / Spacing 25 kHz
2) Radio settings Tx power 35W / Signal threshold -115 dBm / FCS OFF /
TX start delay 0 ms / Compatibility Satel 3AS / Call sign OFF
3) Addressing RX address OFF / TX address OFF /
RX address to RS port OFF / TX address autoswitch OFF
4) Serial port 1 ON / 9600 bit/s / 8 bit data / None parity /
1 stop bit
5) Serial port 2 OFF / 9600 bit/s / 8 bit data / None parity /
1 stop bit (TTL)
6) Handshaking CTS Clear to send / CD RSSI-threshold /
RTS Ignored / Pause length 3 bytes
7) Additional setup Error correction OFF / Error check OFF / Repeater OFF /
SL-commands ON / Priority TX / Full CRC16 check OFF /
User Data whitening OFF
8) Routing OFF
9) Tests OFF
A) Restore factory settings
B) INFO
E) EXIT and save settings
Q) QUIT without saving
Enter selection >
```

### 9.2.3 Changing frequency (active radio channel frequency)

The frequency of the active radio channel, TX or RX or both at the same time, can be changed by selecting main menu selection "1". In the example below the TX frequency is changed from 468.52500 MHz to 468.50000 MHz

```
Enter selection >1  
Radio frequency setup  
-----
```

- 1) Radio frequency
- 2) Channel spacing

```
Enter selection or ESC to previous menu >1  
Radio TX and RX frequency setup  
-----
```

- 1) TX and RX frequency
- 2) TX frequency           468.52500 MHz
- 3) RX frequency           437.00000 MHz
- 4) Reference frequency    438.00000 MHz

```
Enter selection or ESC to previous menu >2  
Radio TX frequency setup  
-----
```

```
TX frequency           468.52500 MHz  
RX frequency           437.00000 MHz  
Lower limit band 1    403.00000 MHz  
Upper limit band 1    473.00000 MHz  
Lower limit band 2    403.00000 MHz  
Upper limit band 2    473.00000 MHz  
Channel spacing       25 kHz
```

```
Enter new TX frequency (MHz) or ESC to cancel >468.500 Enter  
Radio TX frequency setup  
-----
```

```
TX frequency           468.50000 MHz  
RX frequency           437.00000 MHz  
Lower limit band 1    403.00000 MHz  
Upper limit band 1    473.00000 MHz  
Lower limit band 2    403.00000 MHz  
Upper limit band 2    473.00000 MHz  
Channel spacing       25 kHz
```

```
Enter new TX frequency (MHz) or ESC to cancel >
```

To get back to the main menu press ESC, ESC, ESC and then E for Exiting and saving.

Maximum adjustment range of the active radio channel frequency is in between "Lower limit band1/2" and "Upper limit band1/2", (default usable range is the full 70 MHz band). Because of possible deviations in each country and/or region concerning the authorised use of the frequency spectrum local authorities may limit this adjustment range. The frequency band limiting values are factory set and the user cannot change them.

#### **NOTE !**

Adjustment of the active radio channel of the radio modem to frequencies other than those allocated and/or allowed by local authorities is strictly forbidden. Use or intended use of forbidden frequencies may lead to prosecution and penalties. SATEL Oy is not responsible for any illegal use practiced with any devices manufactured and/or sold by SATEL Oy and is not liable to pay any damages or compensation caused by such illegal use.

## 9.2.4 Changing reference frequency

The Reference frequency (also known as "Center frequency") defines the starting point, which is used by the specific SL-command to calculate the channels **above** or **below** the Reference frequency. The calculation is based on the selected channel spacing. The Reference frequency must be in between the upper/lower band limits.

Number 1 is pressed in the Main menu.

```
Enter selection >1  
Radio frequency setup
```

- ```
-----  
1) Radio frequency  
2) Channel spacing
```

```
Enter selection or ESC to previous menu >1  
Radio TX and RX frequency setup
```

- ```
-----  
1) TX and RX frequency  
2) TX frequency      468.50000 MHz  
3) RX frequency      437.00000 MHz  
4) Reference frequency 438.00000 MHz
```

```
Enter selection or ESC to previous menu >4  
Radio reference frequency setup
```

```
-----  
Reference frequency 438.00000 MHz  
Lower limit band 1 403.00000 MHz  
Upper limit band 1 473.00000 MHz  
Lower limit band 2 403.00000 MHz  
Upper limit band 2 473.00000 MHz
```

```
Enter new frequency (MHz) or ESC to cancel >460.000 Enter
```

```
Reference frequency 460.00000 MHz  
Lower limit band 1 403.00000 MHz  
Upper limit band 1 473.00000 MHz  
Lower limit band 2 403.00000 MHz  
Upper limit band 2 473.00000 MHz
```

```
Enter new frequency (MHz) or ESC to cancel >  
To get back to the main menu press ESC, ESC, ESC and then E for Exiting and saving.
```

## 9.2.5 Changing channel spacing

The module can be set to different channel spacing. The values are: 12.5, 20 and 25 kHz.

```
Number 1 is pressed in the Main menu.  
Radio frequency setup
```

- ```
-----  
1) Radio frequency  
2) Channel spacing    25 kHz
```

```
Enter selection or ESC to previous menu >2
```

```
Channel spacing  
-----
```

- ```
1) 12,5 kHz
```

- 2) 20 kHz
- 3) 25 kHz

Enter selection or ESC to previous menu > 1  
Channel spacing

- 
- 1) 12,5 kHz
  - 2) 20 kHz
  - 3) 25 kHz

Enter selection or ESC to previous menu > ESC  
Radio frequency setup

- 
- 1) Radio frequency
  - 2) Channel spacing 12,5 kHz

To get back to the main menu press ESC and then E for Exiting and saving.

## **9.2.6 Changing radio settings**

Radio settings which consist of transmitter output power and receiver sensitivity can be configured by selecting main menu selection "2". In the following example both the transmitter output power (35 W -> 20W) and the receiver sensitivity (-110 dBm->-90 dBm) are changed.

Number 2 is pressed in the Main menu.

Enter selection >2  
Radio setup

- 
- 1) TX power 35 W
  - 2) Signal threshold -115 dBm
  - 3) TX start delay 0ms
  - 4) Free Channel Scan RX Slave / OFF
  - 5) Radio compatibility Satel 3AS
  - 6) Call sign OFF

Enter selection or ESC to previous menu >1  
TX power setup

- 
- 1) 10W
  - 2) 20W
  - 3) 25W
  - 4) 35W

Enter selection or ESC to previous menu >2  
Radio setup

- 
- 1) TX power 20W
  - 2) Signal threshold -115 dBm
  - 3) TX start delay 0ms
  - 4) Free Channel Scan RX Slave / OFF
  - 5) Radio compatibility Satel 3AS
  - 6) Call sign OFF

Enter selection or ESC to previous menu >2  
Signal threshold setup

-----  
Signal threshold -115 dBm

Enter new value (80 - 118) or ESC to previous menu > -110 Enter  
Signal threshold setup

-----

Signal threshold -110 dBm

Enter new value (80 - 118) or ESC to previous menu > -  
To get back to the main menu press ESC (and then E for Exiting and saving).

The maximum useable sensitivity of the receiver is determined by the channel spacing (=radio interface data transfer speed) and also by error correction (utilised or not).

In environments with high levels of interference, and when connection distances are short, it is often beneficial to use a "Signal threshold level" value, which is approximately 10 – 20 dBm above the maximum sensitivity level. This will prevent unnecessary receive attempts caused by noise.

#### **NOTE !**

The setting of the transmitter output power of the radio modem to levels in contradiction with transmitter power levels regulated by local or other governmental authorities is strictly forbidden. Use or intended use of forbidden transmitter power levels may lead to prosecution and penalties. SATEL is not responsible for any illegal use practised with any devices manufactured and/or sold by SATEL and is not liable to pay any damages or compensation caused by such illegal use.

### **9.2.7 Free channel scan**

Free channel scan settings can be set by choosing the 2) Free channel scan from the menu. The options are as follows:

```
Enter selection >2
Radio setup
-----
1) TX power          20W
2) Signal threshold -110 dBm
3) TX start delay   0ms
4) Free Channel Scan RX Slave / OFF
5) Radio compatibility Satel 3AS
6) Call sign OFF
```

```
Enter selection or ESC to previous menu >4
Free Channel Scan settings
```

```
-----
1) Free Channel Scan mode OFF
2) Type of modem      RX Slave
3) FCS Net ID         0000
4) RX listen timeout  500 ms
5) Channel hop threshold -110 dBm
6) Beacon interval    1000 ms
7) Beacon disable timeout 0
8) Add new frequency to list
9) Show free scan frequency list
A) Clear frequency list
```

```
Enter selection or ESC to previous menu >
```

The hardware information can be seen in the main menu

```
***** SATELLINE *****
FW: 06.18.x.xx / HW: SPL0005d+EPT / PV: 05.00 / IM: 05 / S/N: 30032010
```

-----  
FW= Firmware HW=Hardware version PV=Product variant version IM=Interface module  
(Voltage range and interface type) S/N= serial number.

### **9.2.8 Changing addressing settings (primary and secondary RX- and TX-addresses)**

Addressing can be switched ON or OFF with the help of main menu selection "3". In the following example a primary RX-address (receiver address) is switched ON and the corresponding hexadecimal address value is modified ("0000" → "0020"). The current values of the parameters are displayed and changed in toggle-type fashion by selecting the appropriate parameter selection number from the list displayed. The next menu level will then enable the modification of the values (within allowed limits). Modification of all other primary and secondary transmitter and receiver addresses is done in similar way.

Number 3 is pressed in the Main menu.

```
Addressing setup
Toggle ON/OFF values. Current value shown.
```

```
-----
1) RX address                OFF
2) TX address                OFF
3) RX address to RS port    OFF
4) Change primary RX address
5) Change primary TX address
6) Change secondary RX address
7) Change secondary TX address
8) TX address autoswitch    OFF
```

```
Enter selection or ESC to previous menu >1
Addressing setup
Toggle ON/OFF values. Current value shown.
```

```
-----
1) RX address                ON 0000/0000
2) TX address                OFF
3) RX address to RS port    OFF
4) Change primary RX address
5) Change primary TX address
6) Change secondary RX address
7) Change secondary TX address
8) TX address autoswitch    OFF
```

```
Enter selection or ESC to previous menu >4
RX address setup
```

```
-----
RX address ON 0000/0000
```

```
Enter new address (HEX) or ESC to previous menu >0020 Enter
RX address setup
```

```
-----
RX address ON 0020/0000
```

```
Enter new address (HEX) or ESC to previous menu >
```

The new value is displayed in the menu.

To get back to the main menu press ESC (and then E for Exiting and saving).

The address is given in hexadecimal format with four digits and the number of different addresses is thus over 65 000.

### **9.2.9 Changing serial port settings (Port 1)**

The settings of serial **PORT 1** can be modified by selecting main menu selection "4". In the following example, the data transfer speed of PORT 1 is modified (9600 bit/s ->19200 bit/s), followed by the modification of the number of data bits (8 → 7), then the number of parity bits (NONE -> EVEN) and finally the number of stop bits is changed (1 → 2).

#### **NOTE!**

The radio modem has one serial port, **PORT 1** which complies with the RS-232 standard. **PORT 2** is not in use and the settings of serial **PORT 2** cannot be changed.

Number 4 is pressed in the Main menu.

```
Serial port 1
Settings
```

```
-----
1) Port status      ON
2) Data speed      9600 bit/s
3) Data bits       8 bit data
4) Parity bits     None parity
5) Stop bits       1 stop bit
```

Enter selection or ESC to previous menu >2

```
Serial port 1 data speed
```

```
-----
1) 300 bit/s
2) 600 bit/s
3) 1200 bit/s
4) 2400 bit/s
5) 4800 bit/s
6) 9600 bit/s
7) 19200 bit/s
8) 38400 bit/s
```

Enter selection or ESC to previous menu >7

```
Serial port 1
Settings
```

```
-----
1) Port status      ON
2) Data speed      19200 bit/s
3) Data bits       8 bit data
4) Parity bits     None parity
5) Stop bits       1 stop bit
```

Enter selection or ESC to previous menu >3

```
Serial port 1 data bits
```

```
-----
1) 7 bit data
2) 8 bit data
3) 9 bit data
```

Enter selection or ESC to previous menu >1  
Serial port 1  
Settings

- 
- 1) Port status           ON
  - 2) Data speed           19200 bit/s
  - 3) Data bits            7 bit data
  - 4) Parity bits          None parity
  - 5) Stop bits            1 stop bit

Enter selection or ESC to previous menu >4  
Serial port 1 parity bits

- 
- 1) None parity
  - 2) Even Parity
  - 3) Odd Parity

Enter selection or ESC to previous menu >2  
Serial port 1  
Settings

- 
- 1) Port status           ON
  - 2) Data speed           19200 bit/s
  - 3) Data bits            7 bit data
  - 4) Parity bits          Even parity
  - 5) Stop bits            1 stop bit

Enter selection or ESC to previous menu >5  
Serial port 1 stop bits

- 
- 1) 1 stop bit
  - 2) 2 stop bits

Enter selection or ESC to previous menu >2

Serial port 1  
Settings

- 
- 1) Port status           ON
  - 2) Data speed           19200 bit/s
  - 3) Data bits            7 bit data
  - 4) Parity bits          Even parity
  - 5) Stop bits            2 stop bits

Enter selection or ESC to previous menu >  
To get back to the main menu press ESC (and then E for Exiting and saving).

Now all of the modifications of the example have been performed and the new values are displayed:

```
***** SATELLINE *****
FW: 06.18.x.xx / HW: SPL0005d+EPT / PV: 05.00 / IM: 05 / S/N: YYMMxxxx
-----
Current settings
-----
1) Radio frequency    TX: 468.50000 MHz / RX: 437.00000 MHz /
                    Ref freq: 460.00000 MHz / Spacing 12.5kHz
2) Radio settings    TX power 35W / Signal threshold -110 dBm / FCS OFF /
                    TX start delay 0ms / Compatibility Satel 3AS / Call sign OFF
3) Addressing        RX address ON 0020/0000 / TX address OFF /
                    RX address to RS port OFF / TX address autoswitch OFF
4) Serial port 1     ON / 9600 bit/s / 8 bit data / None parity /
                    1 stop bit
5) Serial port 2     OFF / 9600 bit/s / 8 bit data / None parity /
                    1 stop bit (TTL)
6) Handshaking       CTS Clear to send / CD RSSI-threshold /
                    RTS Ignored / Pause length 3 bytes
7) Additional setup  Error correction OFF / Error check OFF / Repeater OFF /
                    SL-commands ON / Priority TX / Full CRC16 check OFF /
                    User Data whitening OFF
8) Routing           OFF
9) Tests             OFF
A) Restore factory settings
B) Info
E) EXIT and save settings
Q) QUIT without saving
```

Enter selection >

Press E for Exiting and saving.

The settings of the serial port must be modified to correspond with the settings of the terminal device that is to be connected to the radio modem.

#### NOTE!

It should be noted that switching the radio modem into *Programming Mode* by connecting the MODE-pin (see chapter 6.2) to ground (GND) will change the settings of serial PORT 1 to "9600,8,N,1" automatically irrespective of the serial PORT 1 DATA-mode settings.

### 9.2.10 Modification of handshaking functions

Handshaking related configuration settings can be modified by selecting the options from the main menu "6". In the following example characteristics of the CTS-line (CLEAR TO SEND → TX BUFFER STATE), CD-line (RSSI-THRESHOLD → DATA ON CHANNEL) and RTS-line (IGNORED → FLOW CONTROL) are changed.

Number 6 is pressed in the Main menu.

Serial ports 1 and 2 Handshaking

```
-----
1) CTS line property Clear to send
2) CD line property  RSSI-threshold
3) RTS line property Ignored
```

4) Pause length           3 bytes

Enter selection or ESC to previous menu >1  
Select CTS line action property

- 1) Clear to send  
2) TX buffer state

Enter selection or ESC to previous menu >2  
Serial ports 1 and 2 Handshaking

- 1) CTS line property TX buffer state  
2) CD line property RSSI-threshold  
3) RTS line property Ignored  
4) Pause length       3 bytes

Enter selection or ESC to previous menu >2  
Select CD line action property

- 1) RSSI-threshold  
2) Data on channel  
3) Always ON

Enter selection or ESC to previous menu >2  
Serial ports 1 and 2 Handshaking

- 1) CTS line property TX buffer state  
2) CD line property Data on channel  
3) RTS line property Ignored  
4) Pause length       3 bytes

Enter selection or ESC to previous menu >3  
Select RTS line action property

- 1) Ignored  
2) Flow control  
3) Reception Control

Enter selection or ESC to previous menu >2  
Serial ports 1 and 2 Handshaking

- 1) CTS line property TX buffer state  
2) CD line property Data on channel  
3) RTS line property Flow control  
4) Pause length       3 bytes

Enter selection or ESC to previous menu >  
To get back to the main menu press ESC (and then E for Exiting and saving).

Now all of the modifications of the example have been performed and the new values are displayed on the menu as follows:

```

***** SATELLINE *****
FW: 06.18.x.xx / HW: SPL0005d+EPT / PV: 05.00 / IM: 05 / /N: YYMMxxxxx
-----
Current settings
-----
1) Radio frequency    TX: 438.00000 MHz / RX: 450.00000 MHz /
                    Ref freq: 438.00000 MHz / Spacing 20kHz
2) Radio settings    TX power 35W / Signal threshold -118 dBm / FCS OFF /
                    TX start delay 0ms / Compatibility Satel 3AS / Call sign OFF
3) Addressing        RX address OFF / TX address OFF /
                    RX address to RS port OFF / TX address autoswitch OFF
4) Serial port 1     ON / 9600 bit/s / 8 bit data / None parity /
                    1 stop bit
5) Serial port 2     OFF / 9600 bit/s / 8 bit data / None parity /
                    1 stop bit ( TTL )
6) Handshaking       CTS TX buffer state / CD Data on channel /
                    RTS Flow control / Pause length 3 bytes
7) Additional setup  Error correction OFF / Error check OFF / Repeater OFF /
                    SL-commands ON / Priority TX / Full CRC16 check OFF /
                    User Data whitening OFF
8) Routing           OFF
9) Tests             OFF
A) Restore factory settings
B) Info
E) EXIT and save settings
Q) QUIT without saving

Enter selection >

```

### 9.2.11 Special functions

Special functions are modified by selecting from the main menu selection "7". The current values of the parameters are displayed and can be modified in toggle-type fashion by choosing the appropriate parameter selection number from the list displayed. The next menu level will then enable the modification of the values (within allowed limits).

```

Number 7 is pressed in the Main menu.
Additional setup
Toggle ON/OFF values. Current value shown.
-----
1) Error correction  OFF
2) Error check       OFF
3) Repeater          OFF
4) SL-commands       ON
5) Priority           TX
6) Full CRC16 check  OFF
7) User Data whiten  OFF

Enter selection or ESC to previous menu >

```

## 9.2.12 Modification of routing

Configuration settings defining routing can be changed by selecting main menu selection "8".

```
Enter selection >8

Routing Setup
-----
1) Mode                OFF
2) Protocol
3) Address
4) Net id
5) Route list
6) Route add
7) Route delete
8) Delete all routes

Enter selection or ESC to previous menu >1

Routing mode setup
-----
1) Disabled
2) Source routing
3) Virtual routing

Enter selection or ESC to previous menu >3

Routing Setup
-----
1) Mode                Virtual routing
2) Protocol            Userdefined 01 01
3) Address             0009
4) Net id              testnet
5) Route list
6) Route add
7) Route delete
8) Delete all routes

Enter selection or ESC to previous menu >2

Protocol set-up
-----
1. Userdefined
2. IEC60870-5-101
3. RP570/571

Enter selection or ESC to previous menu >1
```

<pre>User defined address position setup ----- 1) Start position      01 2) Length              01  Enter selection or ESC to previous menu &gt;1</pre>	
	<pre>User defined address start position setup ----- Current value: 01  Enter new start position (0-16) &gt;02  User defined address start position setup ----- Current value: 02  Enter new start position (0-16) &gt;ESC</pre>
<pre>User defined address position setup ----- 1) Start position      02 2) Length              01  Enter selection or ESC to previous menu &gt;2</pre>	
	<pre>User defined address length setup ----- Current value: 01  Enter new length (1-4) &gt;3  User defined address length setup ----- Current value: 03  Enter new length (1-4) &gt;ESC</pre>
<pre>User defined address position setup ----- 1) Start position      02 2) Length              03  Enter selection or ESC to previous menu &gt;ESC</pre>	

The display has now returned to the main menu of the routing settings and it can be seen that the routing mode (*Virtual Mode Routing*) as well as the protocol (USERDEFINED 02 03) have been modified.

Following this, a new address will be modified ("0009" → "0002") and a new Network ID is defined ("testnet" → "newname"):

```
Routing Setup
-----
1) Mode           Virtual routing
2) Protocol       Userdefined 02 03
3) Address        0009
4) Net id         testnet
5) Route list
6) Route add
7) Route delete
8) Delete all routes

Enter selection or ESC to previous menu >3

Address setup
-----
Current routing address 0009

Enter new address (HEX) or ESC to previous menu >0002

Address setup
-----
Current routing address 0002

Enter new address (HEX) or ESC to previous menu >ESC

Routing Setup
-----
1) Mode           Virtual routing
2) Protocol       Userdefined 01 01
3) Address        0002
4) Net id         testnet
5) Route list
6) Route add
7) Route delete
8) Delete all routes

Enter selection or ESC to previous menu >4

Net id
-----
Net id current value: testnet

Enter net id (8 char) or ESC to previous menu >newname

Net id
-----
Net id current value: newname

Enter net id (8 char) or ESC to previous menu >ESC
```

```
Routing Setup
-----
1) Mode           Virtual routing
2) Protocol       Userdefined 01 01
3) Address        0002
4) Net id         newname
5) Route list
6) Route add
7) Route delete
8) Delete all routes
Enter selection or ESC to previous menu >ESC
```

Selection "5" will produce a list of the routes:

```
Route list
-----
xxx
xxx
xxx
Press any key to return >
```

Selection "6" enables the addition of a route:

```
Route add
-----
Enter destination address (HEX) >
```

Selection "7" enables the removal of a route:

```
Route delete
-----
Enter destination address (HEX) >
```

Selection "8" enables erasure of ALL routing information simultaneously. The menu will then display the following text:

```
Routing Set-up
-----
1) Mode           Virtual routing
2) Protocol       Userdefined 02 03
3) Address        0009
4) Net id         testnet
5) Route list
6) Route add
7) Route delete
8) Delete all routes
Enter selection or ESC to previous menu >8
Do you really want to delete all routes?
Press Y key to delete or ESC to cancel >
```

### 9.2.13 Activating tests

Tests can be activated by selecting main menu selection "9". Tests are activated by setting the status of the desired test to "ON" and will remain active until the value of the selection in the menu is returned to the value "OFF".

```
Enter selection >9
Tests setup
-----
1) Short block test      OFF
2) Long block test      OFF
```

**NOTE!** Message Routing and FCS mode must be disabled in prior to set ON the Test mode.

### 9.2.14 Restoring factory settings

The settings that the modem was delivered from the factory are called "factory settings". Selecting main menu selection "A" can restore factory settings.

```
Enter selection >A
Restore factory settings
-----
Do you want to restore factory settings? (Y/N)>
```

Restoring is confirmed by pressing "Y" (Y=YES) or cancelled by pressing "N" (N=NO). Also the pressing of "ESC" button at any point in the procedure will return the display to the previous (next higher) menu level without restoring factory settings.

### 9.2.15 Info

The Info display shows all the functionality of the modem.

Device = Modem type. Serial number= yyyymmddxxx. FW version= xx.xx.xx.xx.  
Board version= Main board version SPLxxxxn. Module version= Voltage range, Port 2 interface. Tuning range= Total tuning range.

```
Enter selection >b
Info menu
-----
Device:                SATELLINE EASy-35W
Serial number:         xxxxxxxxxxxxxx
FW version:            06.18.x.xx
Board version:         SPL0005d+EPT
Module version:        Voltage: 9-16V
Tuning range:          403.00000 - 473.00000 MHz

Press any key to return >
```

### 9.2.16 Saving modified settings into the permanent memory

All modified settings must be saved into the permanent non-volatile memory of the radio modem before switching out of the *Programming Mode*. Selecting the main menu selection "E" automatically saves the settings:

```
Enter selection >E
```

```
Configuration saved!  
Please turn off program mode switch!
```

**NOTE!** To switch the radio modem back into *Data Transfer Mode* the MODE-pin of the must be disconnected from ground (GND). See chapter 6.2

### 9.2.17 Updating Firmware

The Firmware of SATELLINE-EASy Pro 35W is stored in a flash memory. It can be updated by SaTerm terminal program or SATEL Configuration Manager.

## 9.3 Changing parameters using the LCD-display

SATELLINE-EASy Pro 35W contains an LCD-display that shows the valid functions and allows modification of the settings.

On standby mode the LCD-display will shortly display the basic information, which is revolving automatically in **5 seconds**. The following settings are shown: TX and RX frequencies, Compatibility, TX Power and Channel Spacing, Reference frequency and Com Port 1.

The radio modems configuration settings can be done without the use of an external terminal device. This is especially convenient when modifying or re-installing radio modems in the field. The radio modem is switched into *Programming Mode* by pressing the "SET-UP-button (■).

The main menu is used to select the desired submenus, and the modifications are performed using these submenus. It is possible to jump back at any time to the previous (higher) level in the menu hierarchy by just pressing the "CANCEL"-button (or in some cases the "BACK"-button). Pressing the ▲ or ▼ button modifies parameters with numerical values consisting of digits. Use until the said digit (with the cursor blinking under it) has reached the desired value. In the case of numerical values the "NEXT"-button is used to move on to the next digit in the numerical value and then the above described process is used to modify it. The process is repeated until all digits in the value have been edited. Toggle-type parameters (typically with ON/OFF choices modifications have to be confirmed by pressing the "SELECT"- or "SET"-button.

This is the display in *Data Transfer Mode*.

TX and RX frequencies are set to 468.525.000 MHz.

Compatibility is Satel 3AS.

TX power is 35W.

Channel spacing is 25 kHz.

Reference frequency is 438.000.000 MHz. Serial **PORT 1** settings are 19200, N, 8, 1.

Signal strength info is displayed on the upper left-hand corner:

- RSSI value **Y-102** (here -102 dBm) of the last received message or

- current noise level e.g. **n-115**

Battery level respectively on the upper right corner.

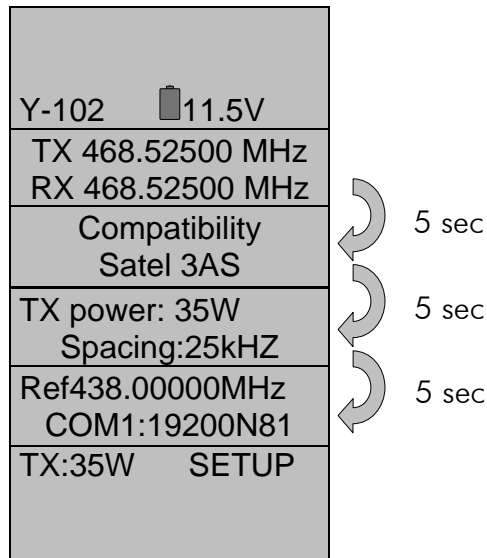

After pressing the "SET-UP-button the display will show the main menu, which is a list of modifiable parameters.

Pressing the buttons the cursor moves upwards and downwards. When the cursor > is placed beside the desired selection, entry into sub-menu is done by pressing the SELECT- button.

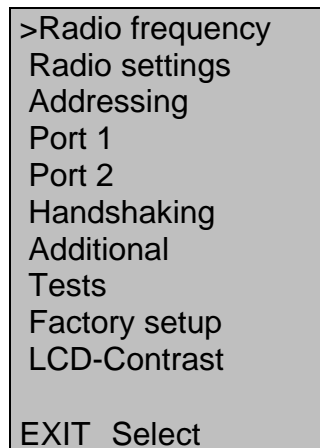

### 9.3.1 Changing frequency (frequency of the active TX/RX radio channel)

Press until the cursor > points to "Radio frequency" – selection and press "Select" to move onto the next submenu.

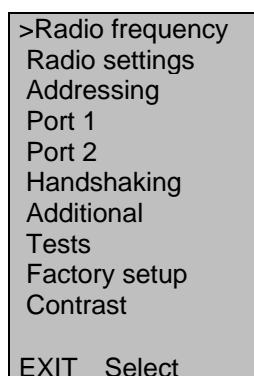

TX & RX freq: changes **both** TX and RX frequencies at the same time.  
 TX freq: changes **only** the TX frequency.  
 RX freq: changes **only** the RX frequency.  
 Press **>** until the cursor **>** points at the correct selection and Press "CHANGE" if the frequency is to be modified.

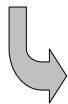

```
>TX & RX freq
TX freq
RX freq
Reference freq
Ch Spacing

BACK  Change
```

**TX & RX freq selected**

The frequency Band 1 limits will be shown. Press **▼** and to get the Band 2 limits. Press "Set" to activate the change frequency window.

```
Band 1 limits
Lo 403.00000 MHz
Hi 473.00000 MHz

Cancel  Set
```

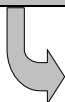

The cursor **>** will now blink under the first digit of the value indicating the (this first digit cannot be edited). To move onto the next digit, press "Next".

```
New common freq
468.52500 MHz
^

Cancel  Next
```

Press **>** until the said digit has reached the desired value. Press "NEXT" to move on to the next digit and repeat the above-described steps.  
 Previous steps are repeated four (4) times.  
 Press **>**, until the last changeable digit has the desired value and confirm changes by pressing "Set". The following information will be displayed for a few seconds.



**Ch accepted**  
**468.52500 MHz**

The radio modem will acknowledge changes if they are between band limits. The display will return automatically to display the main menu (if the entered frequency is not acceptable an error message will be displayed).

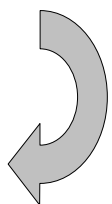

```
CF 468.50000
MHz
>468.20000 MHz
^
CANCEL  SET

Ch accepted
>468.20000 MHz
```

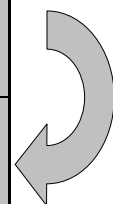

**CHECKING/CHANGING THE REFERENCE FREQUENCY**

Press SETUP, set cursor at the Radio frequency and press Select.

```
>Radio frequency
Radio settings
Addressing
Port 1
Port 2
Handshaking
Additional
Tests
Factory setup
Contrast
EXIT Select
```

Press **Change** until the cursor points at "Reference freq" selection and press "Change".

```
TX & RX freq
TX freq
RX freq
> Reference freq
Ch Spacing
Back Change
```

Band 1 limits are shown.  
By pressing **Change** again the display will show **Band 2** limits (these values cannot be changed).

```
Band 1 limits
Lo 403.00000 MHz
Hi 473.00000 MHz
Cancel Set
```

To activate Reference frequency window, press Set.

```
Band 2 limits
Lo 467.2000 MHz
Hi 469.2000 MHz
Cancel Set
```

The display will now show  
New Ref freq  
438.00000 MHz  
^

**The cursor** > will now blink under the first digit of the value indicating the (this first digit cannot be edited). To move onto the next digit, press "**Next**". Previous steps are repeated four (4) times. Press **Change**, until the last changeable digit has the desired value and confirm changes by pressing "Set". The following information will be displayed for a few seconds.

**Ch accepted**  
**468.52500 MHz**

The radio modem will acknowledge changes if they are between band limits. The display will return automatically to display the main menu (if the entered frequency is not acceptable an error message will be displayed).

```
New common freq
468.52500 MHz
Cancel Next
```

### 9.3.2 Changing radio settings (transmitter power and receiver sensitivity)

Press  $\leftarrow$  until the cursor  $>$  points to "Radio settings" selection and press "Select" to move on to the submenu.

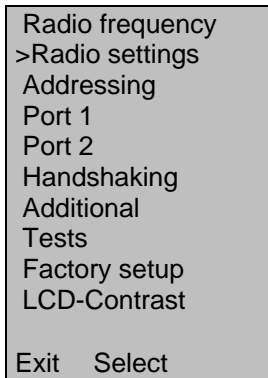

Press  $\leftarrow$  until the cursor  $>$  points to the setting to be modified and press "Change".

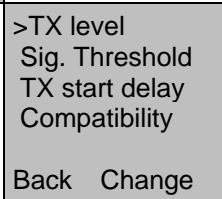

#### MODIFYING TRANSMITTER OUTPUT POWER:

The displayed list consists off all possible values of transmitter output power. Press  $\leftarrow$  until the cursor  $>$  points to the desired value and press "SET".

**NOTE:** The starting position of the cursor indicates the previously set value.

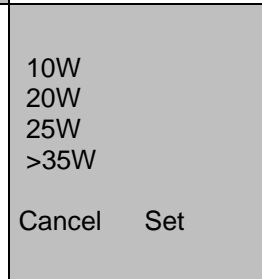

#### MODIFYING RECEIVER SENSITIVITY:

The displayed list consists off all possible values of receiver sensitivity. Press  $\leftarrow$  until the cursor  $>$  points to the desired value and press "SET".

**NOTE:** The starting position of the cursor indicates the previously set value.

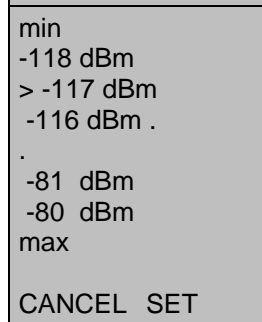

#### MODIFYING THE TRANSMIT START DELAY:

The display will show the current value of the delay. Press "Change" to modify the value.

Press  $\leftarrow$  until the first digit of the value has reached the desired value and then press "NEXT" to move on to the next digit.

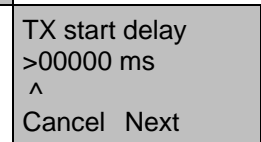
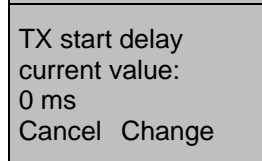

Repeat the above described five (5) times.

⋮

Press  $\leftarrow$  until the last changeable digit has the desired value and finally confirm changes by pressing "SET".

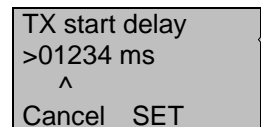

MODIFYING THE COMPATIBILITY:

Press until the cursor > points to the setting to be modified and press "Change".

TX level  
Sig. Threshold  
TX start delay  
>Compatibility  
Back Change

The display will show the current value. Press until the cursor > points to the desired value and press "SET".

>SATEL 3AS  
Option 1  
Option 2  
Option 3  
Cancel Set

MODIFYING THE CALL SIGN:

Press until the cursor > points to the setting to be modified and press "Change".

Sig. Threshold  
TX start delay  
Compatibility  
>Call sign  
Back Change

The display will show the current value. Press until the cursor > points to the desired value and press "SET".

>Call sign OFF  
Call sign ON  
Cancel Set

**9.3.3 Changing addressing**

Press until the cursor > points to "Addressing" selection and press "SET-UP" to move on to the submenu.

Radio frequency  
Radio settings  
>Addressing  
Port 1  
Port 2  
Handshaking  
Additional  
Test  
Factory setup  
LCD-Contrast  
EXIT Select

Select the desired submenu (RX or TX address) by pressing and finally press "Change".

>RX addr OFF  
TX addr OFF  
RX addr->RS OFF  
TX add auto OFF  
Back Change

Press until the first digit of the address has reached the desired value and move on to the next digit by pressing "NEXT".

Repeat the above described eight (8) times.

Press NEXT again to jump to the toggle field (ON/OFF) and change the status to the desired value by pressing until correct status is reached. Confirm the new address and status (ON/OFF state) by pressing "SET".

The display will return to the previous (higher) level submenu.

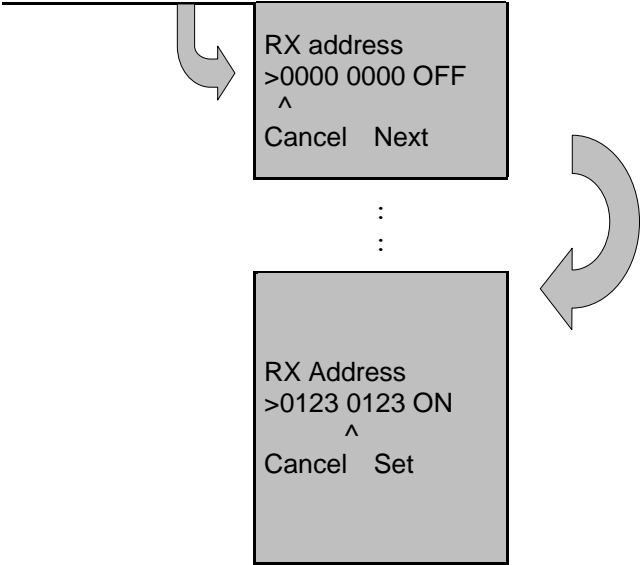

**NOTE:** Both RX and TX address modifications are done in the same way as described above.

### 9.3.4 Changing serial port settings (Port 1)

**NOTE!**

The radio modem has one serial port, **PORT 1** which complies with the RS-232 standard. **PORT 2** is not in use and the settings of serial **PORT 2** cannot be changed.

Press **<** until the cursor **>** points to the desired port (in this example to **Port 1**) and move on to the submenu by pressing "SELECT".

```
Radio frequency
Radio settings
Addressing
>Port 1
Port 2
Handshaking
Additional
Tests
Factory setup
LCD-Contrast
Exit Select
```

Press **<** until the cursor **>** points to the setting to be modified and then press "CHANGE".

```
ON
>19200 bit/s
8 bit data
None parity
1 stop bit
Back Change
```

MODIFICATION OF DATA TRANSFER SPEED:

Press **<** until the cursor **>** points to the desired data transfer speed value (X bit/s). Confirm the selection by pressing "SET". The display will return to the previous (higher) level submenu.

**NOTE:** The starting position of the cursor indicates the previously set value.

```
300 bit/s
600 bit/s
1200 bit/s
2400 bit/s
4800 bit/s
9600 bit/s
>19200 bit/s
38400 bit/s
Cancel Set
```

MODIFICATION OF THE NUMBER OF DATA BITS:

Press **<** until the cursor **>** points to the desired number of data bits (7 or 8 or 9 bit data length). Confirm the selection by pressing "SET". The display will return to the previous (higher) level submenu.

**NOTE:** The starting position of the cursor indicates the previously set value.

```
7 bit data
>8 bit data
9 bit data
Cancel Set
```

MODIFICATION OF PARITY BITS:

Press **<** until the cursor **>** points to the desired parity bit status. Confirm the selection by pressing "SET". The display will return to the previous (higher) level submenu.

**NOTE 1:** The starting position of the cursor indicates the previously set value.

**NOTE 2:** If the number of data bits is set to 9, the value of parity bits must be set to NONE (no parity).

```
>None parity
Even parity
Odd parity
Cancel Set
```

MODIFICATION OF THE NUMBER OF STOP BITS:

Press  $\rightarrow$  until the cursor  $>$  points to the desired number of STOP bits. Confirm selection by pressing "SET". The display will return to the previous (higher) level submenu.

**NOTE:** The starting position of the cursor indicates the previously set value.

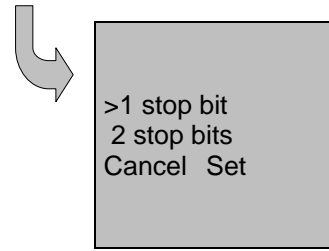

**9.3.5 Modification of handshaking functions**

Press  $\rightarrow$  until the cursor  $>$  points to "Handshaking" selection and move on to the submenu by pressing "SELECT".

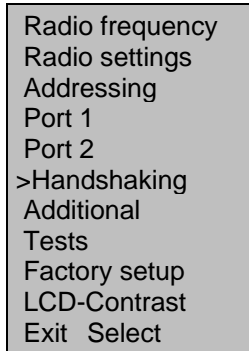

There are three (3) submenus relating to handshaking parameters. Press  $\rightarrow$  until the cursor  $>$  points to the desired submenu selection and press "CHANGE".

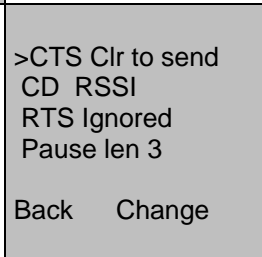

DEFINING CTS-LINE FUNCTIONS:

Press  $\rightarrow$  until the desired function is indicated by the cursor  $>$  and confirm selection by pressing "SET". The display will return to the previous (higher) level submenu.

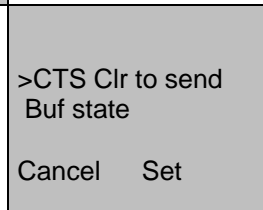

DEFINING CD-LINE FUNCTION:

Press  $\rightarrow$  until the desired function is indicated by the cursor  $>$  and confirm selection by pressing "SET". The display will return to the previous (higher) level submenu.

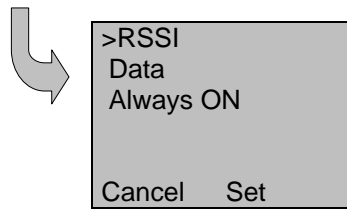

DEFINING RTS-LINE STATUS:

Press  $\rightarrow$  until the desired function is indicated by the cursor  $>$  and confirm selection by pressing "SET". The display will return to the previous (higher) level submenu.

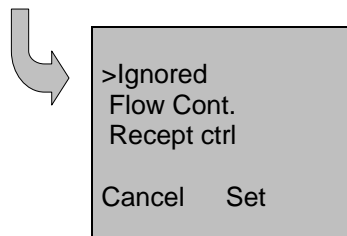

### 9.3.6 Selecting special functions

Press  $\rightarrow$  until the cursor  $>$  points to "Additional" selection and press "SELECT" to move on to the submenu.

```
Radio frequency
Radio settings
Addressing
Port 1
Port 2
Handshaking
>Additional
Test
Factory setup
LCD-Contrast
Exit Select
```

Press  $\rightarrow$  until the cursor  $>$  points to the setting to be modified. Press "CHANGE" to toggle the status of the said parameter from "ON" to "OFF" and vice versa. Press "CHANGE" until the parameter has the desired status. Repeat for all special functions to be modified and finally confirm all changes by pressing "BACK". The display will return to the previous (higher) level submenu.

```
>Error corr. OFF
Error check OFF
Repeater OFF
SL-commands OFF
Priority TX
Full CRC16 OFF
Data whiten OFF

Back Change
```

### 9.3.7 Activating tests

Press  $\rightarrow$  until cursor  $>$  points to "Tests" selection and press "SELECT" to move on to the submenu.

```
Radio frequency
Radio settings
Addressing
Port 1
Port 2
Handshaking
Additional
>Tests
Factory set-up
LCD-Contrast
Exit Select
```

Press  $\rightarrow$  until cursor  $>$  points to the test that is to be initiated. Press "CHANGE" to toggle the status of the selected test from "ON" to "OFF" and vice versa. After the tests have been set to desired states confirm all changes by pressing "BACK". The display will return to the previous (higher) level submenu. When the tests have been switched ON the TD led is green. Test signal will be activated by pressing BACK and saving the setting.

```
>Short Block OFF
Long Block OFF

Back Change
```

### 9.3.8 Restoring factory settings

Press  $\rightarrow$  to move cursor  $>$  to point to "Factory set-up" selection and press "SELECT" to move on to the submenu.

```
Radio frequency
Radio settings
Addressing
Port 1
Port 2
Additional
Test
>Factory setup
LCD-Contrast
Exit  Select
```

Press "YES" and all radio modem configuration settings will return to factory settings (which are the ones that the modem was delivered).

```
Do you want to
restore factory
settings?
NO  YES
```

### 9.3.9 Adjusting the contrast of the LCD-display

Press  $\rightarrow$  to move the cursor  $>$  to point to "Contrast" selection and press "Select" to move on to the submenu.

```
Radio frequency
Radio settings
Addressing
Port 1
Port 2
Additional
Test
Factory set-up
>LCD-Contrast
Exit  Select
```

The display will show the current value of contrast. To modify contrast setting press "Change".

```
Display contr.
3
Back  Change
```

Press  $\rightarrow$  until the cursor  $>$  points to the desired contrast level value. Confirm selection by pressing "SET". The display will return to the previous (higher) level submenu.

**NOTE:** The modified contrast value will actually take effect only after the radio modem is switched out from Programming Mode back into Data Transfer Mode.

**NOTE:** The starting position of the cursor indicates the previously set value.

```
1
2
>3
4
5
Inverted
Cancel Set
```

### 9.3.10 Saving modified values into the internal memory

After all desired modifications have been performed; they have to be saved in order to make them permanent (until next modification). This is accomplished by choosing selection "EXIT" from the main menu. The display will then show a message (see below) asking a confirmation of the performed modifications.

By choosing "YES" all modifications are saved into the non-volatile memory inside the radio modem. By choosing "NO" all modification performed are cancelled and previous settings remaining in the non-volatile memory.

Press "YES" to save all modifications into the non-volatile memory and "NO", if modifications are to be cancelled.

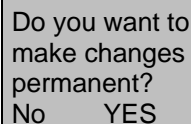

Do you want to  
make changes  
permanent?  
No YES

## 9.4 Changing parameters using the SL-commands

The controlling terminal device can change the configuration settings of a radio modem. This is accomplished with the help of SL-commands, which can be used during data transfer. SL-commands can be used to change e.g. the frequency or addresses. It is also possible to interrogate a radio modem in order to gain information concerning current settings that are in use. The terminal device is either a PC or a programmable logic (PLC) together with suitable (terminal) program. SL-commands must be enabled using *Programming Mode* before they can be used.

An SL-command is a one continuous string of characters, which is separated from other data by pauses that are equal or greater than time defined by Pause length parameter in the set-up. No extra characters are allowed at the end of an SL-command. Serial interface settings are the same as in data transfer and pin 12 of the serial connector MUST NOT be connected to ground (GND). SL-command is properly recognised also in the case when the command string is terminated in <CR> (=ASCII character no. 13, Carriage Return, 0x0d) or <CR><LF> (<LF> = ASCII char. no. 10, Line Feed, 0x0a). If multiple SL commands are sent to the radio modem the next command can be given after receiving the response ("Ok" or "Error") of the proceeding command. In addition, it is recommended to implement a timeout to the terminal software for recovering the case when no response is received from the radio modem.

When the power of a radio modem is switched off the configuration settings of a radio modem always return to values defined initially using the *Programming Mode*, thus resetting any settings changed using SL-commands during power on. It is however possible to save settings changed by using SL-commands and to make them the new configuration settings.

The radio modem will acknowledge all commands by returning an "OK" (command carried out or accepted) or the requested value, or an "ERROR" (command not carried out or interpreted as erroneous) message.

In case you need more information on the time delays related to the use of SL-commands, please contact the manufacturer.

In order to get information of the latest and/or special SL-commands please contact SATEL Oy.

### 9.4.1 Frequency

Command	Effect and description of command
SL&FR=nnn.nnnnn	Set RX-frequency to nnn.nnnnn MHz
SL&FT=nnn.nnnnn	Set TX-frequency to nnn.nnnnn MHz
SL&F=nnn.nnnnn	Set both RX&TX-frequency to same nnn.nnnnn MHz
SL&FR?	Get RX- frequency (response 'nnn.nnnnn MHz')
SL&FT?	Get TX- frequency (response 'nnn.nnnnn MHz')
SL&F?	Get RX&TX- frequencies (response TX nnn.nnnnn MHz, RX nnn.nnnnn MHz)
SL&C?	Get Reference (Center) frequency (response 'nnn.nnnnn MHz')
SL&C=nnn.nnnnn	Set Reference (Center) frequency to nnn.nnnnn MHz
SL&+=nn	Set RX&TX- frequency nn channels above reference frequency Frequency = Reference frequency + nn * Channel spacing, where nn=[0...Number of channels/2]
SL&-=nn	Set RX&TX- frequency nn channels below reference frequency Frequency = Reference frequency - nn * Channel spacing, where nn=[0...Number of channels/2]
SL&N?	Get current RX&TX- frequency deviation from reference frequency as channels (Frequency - Center frequency)/Channel spacing (response '+nn' or '-nn')
SL&W?	Get channel spacing (response 'nn.n kHz')
SL&D=x	Set operational mode of the radio. The different values of x are: "S" = Single Channel "D" = Dual Channel "R" = Reverse Dual Channel <b>Note!</b> Use this command only, if the setup of the frequency bands matches the Dual Channel operation.
SL&D?	Get operational mode of the radio. The response is one of the following: "S" = Single Channel "D" = Dual Channel "R" = Reverse Dual Channel <b>Note!</b> Use this command only, if the setup of the frequency bands matches the Dual Channel operation.

### 9.4.2 Addressing

xxxx = address in hexadecimal format (0000 ... FFFF)

Command	Effect and description of command
SL#I=xxxx	Set all addresses (RX1, RX2, TX1, TX2) to value xxxx
SL#I?	Get both primary addresses (TX1, RX1) (response 'xxxx;yyyy')
SL#T=xxxx	Set both transmit addresses (TX1, TX2) to value xxxx
SL#T?	Get primary transmit address (TX1) (response 'xxxx')
SL#R=xxxx	Set both receive addresses (RX1, RX2) to value xxxx
SL#R?	Get primary receive address (RX1) (response 'xxxx')
SL#Q=x	Set TX address on x=1, off x=0
SL#Q?	Get status of the TX address (response '1' on, response '0' off)
SL#W=x	Set RX address on x=1, off x=0
SL#W?	Get status of the RX address (response '1' on, response '0' off)
SL#P=xxxx;yyyy	Set primary transmit address (TX1) to value xxxx and receive address (RX1) to value yyyy
SL#S=xxxx;yyyy	Set secondary transmit address (TX2) to value xxxx and receive address (RX2) to value yyyy
SL#P?	Get primary transmit address (TX1) and receive address (RX1) (response 'xxxx;yyyy')
SL#S?	Get secondary transmit address (TX2) and receive address (RX2) (response 'xxxx;yyyy')
SL#A=xxxx,yyyy, wwwwww,zzzz	Set addresses to values TX1=xxxx TX2=yyyy RX1=wwww RX2=zzzz
SL#A?	Get all addresses (response 'xxxx, yyyy, wwwwww, zzzz')

### 9.4.3 Radio parameters

Command	Effect and description of command
SL@R?	Get field strength of the last received message (the value is an average of many measurements made during the same reception). Response "-xx dBm", where xx is a decimal value of the field strength and it is between -80 dBm and -118 dBm. Value available 7s after reception. SATELLINE-3AS Epic returns the stronger value of two receivers.
SL@P=xxxxx	Set RF output power, where xxxxx is the decimal value of the intended power in mW. If the given value does not correspond to one of the programmed power levels, the output power is set to the nearest possible value.
SL@P?	Get RF output power. Response "xxxxx mW", where xxxxx is a decimal value the output power of the transmitter.
SL@T=-xxx	Set minimum power level of the signal to be received (= "Signal Threshold level"), where xxx is a decimal value of the new intended level in dBm.
SL@T?	Get current "Signal Threshold Level". Response is "-xxx dBm".
SL@D=x	Set TX delay. Value x = 0...65535 ms
SL@D?	Get TX delay value. Response 'x ms'
SL@F?	Get current noise level on the radio channel. Response "-xxx dBm".

#### 9.4.4 Other functions

Command	Effect and description of command
SL**>	Set current settings as permanent settings. This command must be used only seldom and under controlled conditions in order to avoid the corruption of the settings, which may happen in case the power supply fails in the middle of the memory save procedure.
SL%V?	Get Firmware revision information (response 'Vn.nn')
SL%D?	Get modem type
SL%S?	Get modem serial number (response 'nnnnnnnnn' or 'No Serial nr')
SL%C?	Get specified information field. If not specified the response is 'No version id'. For more information please contact SATEL Oy.
SL%P=1	Activate <i>Programming mode</i> without the use of PROG pin. Note that the serial port data speed remains the same as in the data transfer mode.
SL%B?	Get serial data parameters, response is a,b,c,d where a= "38400", "19200", "9600", "4800", "2400" or "1200" (defines the baud rate) b= "8", "7" or "9" (defines the character length) c= "N", "E" or "O" (defines the parity) d= "1" or "2" (defines the number of stop bits)
SL%B=a,b,c,d	Set serial data parameters for data ports, where a= "38400", "19200", "9600", "4800", "2400" or "1200" (defines the baud rate) b= "8", "7" or "9" (defines the character length) c= "N", "E" or "O" (defines the parity) d= "1" or "2" (defines the number of stop bits) Response is "OK" at the original baud rate.
SL+P=xx	Get measured signal strength from the remote modem i.e. SL "ping". If a remote radio modem is pinged the response is "OK, Modem xxx rssi -80 dBm", where xxx=RX1/RX2 address (in case the Tx/Rx addressing is configured) or the terminal address of the modem ( in case the Message Routing is ON). "OK" is first received from the current radio modem to acknowledge that the SL-ping command has been interpreted correctly. The rest of the response will take a little longer to come, depending on the length of the radio link. The remote radio modem that is to be pinged does not need to have SL-commands ON. The value of the RSSI is between -118 and -80 dBm. If the signal strength is better than -80 dBm, -80 dBm is shown. If the current radio modem is pinged, the response is "Local OK". Please note that the SL-ping message will come out from the serial line of the radio modem that is pinged and also the repeater stations using the Tx/Rx addressing. Note, SL-ping is a very short message so it may not give accurate results from the link condition. Even if the responses are good, channel interference may cause problems with longer data messages.

## 10 REPEATER MODE AND ADDRESSING

Repeaters and addressing may be used to extend the coverage area of a radio modem network, and to direct messages to selected radio modems in the network. In large systems, with several repeaters and formed repeater chains, it is often practical to use routing instead of plain addresses.

### 10.1 Repeater

In circumstances where it is necessary to extend the coverage area of a radio modem network, SATELLINE-EASy Pro 35W can be used as repeater stations.

The maximum size of a repeated data packet is 1kB (kilobyte). The *Repeater Function* is switched on using the *Programming Mode*. In the repeater mode the radio modem will function as a totally independent unit, which means that only a power supply and a suitable antenna are needed. Other devices are not necessary.

A radio modem acting as a repeater can also be used to receive and transmit data. In repeater mode the radio modem will transmit the received data to the serial interface in a normal fashion. The difference being that the received data will be buffered into the buffer memory. After reception the radio modem will re-transmit the buffered data using the same radio channel as in reception. Data received through the serial interface a radio modem in repeater mode will transmit normally.

The same network may include several repeaters, which operate under the same base station. Repeaters may also be chained; in which case a message is transmitted through several repeaters. In systems with more than one serially or parallelly chained repeater, addressing or routing protocol must be used to prevent a message ending up in a loop formed by repeaters, and to ensure that the message finally reaches only the intended radio modem.

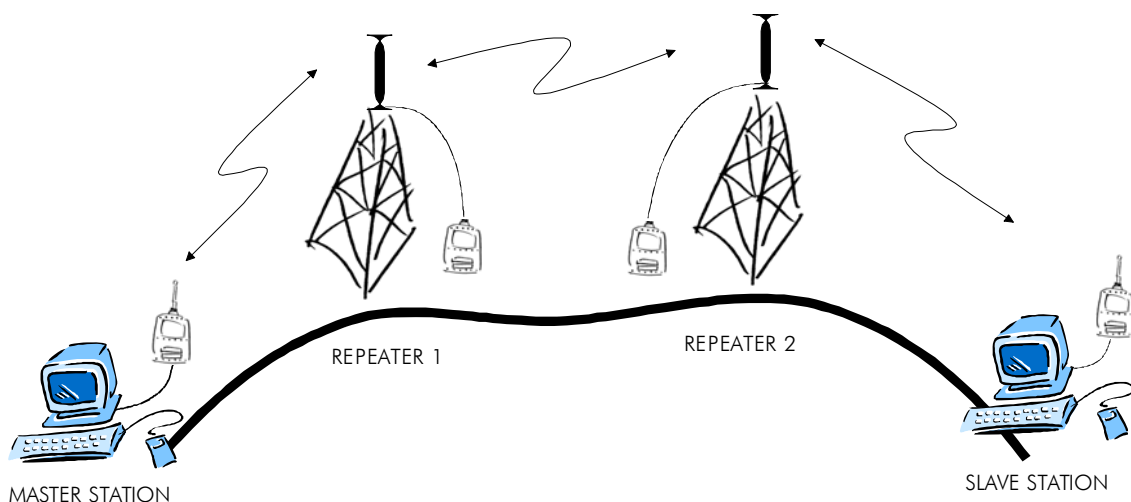

## 10.2 Addressing

Addresses can be used to route a data message to the desired destination or to separate two parallel networks from each other. In networks with repeaters it is usually necessary to use addresses to prevent data messages from ending up in loops formed by repeaters. In case of setting the "Message Routing" function in use, Tx / Rx addresses are ignored by the modem.

SATELLINE-EASy Pro 35W allows the use of individual addresses both for reception and transmission. Addresses can be switched on separately, or simultaneously, in both data transfer directions.

The radio modem contains two transmission and two reception addresses, which are known as the primary address and secondary address. The primary address is used whenever data from the serial interface is transmitted. At the receiving end, the radio modem will receive using either of the two receive addresses.

**Secondary transmit address is only used in repeater applications.**

Radio modems configured to function as repeaters, will repeat data messages using either the primary or secondary address, depending upon which address was used during the reception of the data message.

**If only one address pair is needed in a network, both addresses must be set the same (TX1 = TX2 and RX1 = RX2).**

It is also possible to transfer the received address onto the serial interface.

The address is composed of two characters totalling 16 bits, resulting in over 65,000 different address combinations. The address is attached to the beginning of each data packet sent by the radio modem. When a radio modem receives a data packet whilst using addressing mode, the radio modem will check the first two characters of each received data packet to ensure that the packet in question was intended for the correct radio modem.

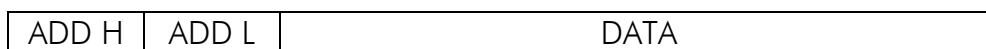

Address may be selected between 0000h...FFFFh (h = hexadecimal, corresponding decimal numbers are 0-65535).

**Example:** address 1234h (4660 in decimal format), where 12h is ADD H and 34h is ADD L.

**Example:** address ABFFh (44031 in decimal format), where ABh is ADD H and FFh is ADD L.

**Transmission:**

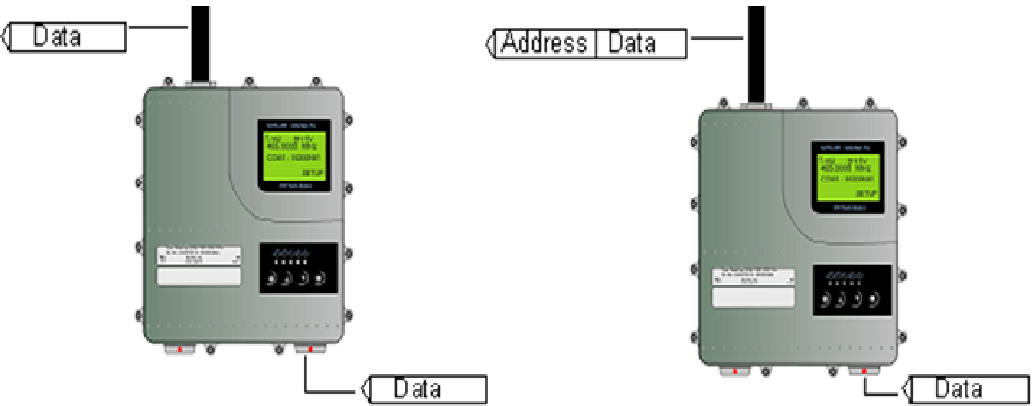

Transmission address has been set OFF. Radio modem will transmit the data packet as such.

Transmission addressing has been set ON. The radio modem will add the primary TX address to the beginning of the data packet.

**Reception:**

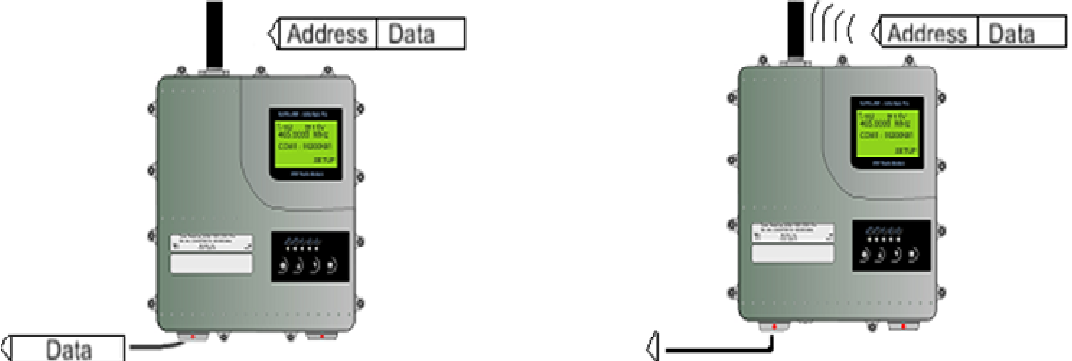

Reception addressing has been set ON and either the primary or secondary RX address of the radio modem is identical to the address of the received data packet.

The radio modem will remove the address and send the actual data to the RS-232 interface.

However, if the "RX Address to RD-line" setting is on, the radio modem does not remove the address.

Reception addressing has been set ON, but both the primary and secondary RX addresses of the radio modem are different from the address of the received data packet.

Data does not appear on the RS-232 interface.



Reception addressing has been set OFF.

The radio modem will transfer all received data to the RS-232 interface.

Reception addressing has been set OFF.

The radio modem will consider the characters of the address as a part of the data and will send all the characters to the RS-232 interface.

Reception addressing has been set ON but there is no address in the data packet.

Data will appear on the RS-232 interface ONLY if the first 2 characters of the data match either of its own RX address. The radio modem will remove those 2 characters of data.

### 10.2.1 Connection between two points

When forming a connection between two points it is recommended that both the reception and transmission addresses are identical in both radio modems. This is the easiest way to control addresses and the risk caused by interference from other systems operating in the same area is minimal.

**Example:** by setting all addresses of both radio modems to a value '1234', they will accept only those messages which contain this address, and they will use this same value when transmitting data.

If the channel is reserved for use only by the said network, or if the terminal devices are responsible for addressing, it is not necessary to use addressing in the radio modems.

### 10.2.2 System of one base station and several substations

In systems with several substations, the base station must know to which substation each message is intended, and from which substation each received message originates. Usually terminal devices handle addressing completely, but it is also possible to use the addressing functionality of the radio modems.

For example, if the substation terminal devices are not able to check and form addresses by themselves, addressing may be achieved with the help of the addresses of the radio modems attached to these terminal devices. The base station may, in such a case, define the destination of a message by adding the address of the corresponding radio modem into the beginning of the data packet. The substation radio modem(s) will check the address and the corresponding radio modem will identify and remove the address characters. In a similar way, the substation will add when transmitting to the base station its address characters into the beginning of the data packet, thus defining the origin of the sent data packet. In the base station radio modem, addresses have been switched OFF, so that they are transmitted as is to the base station terminal device for further processing.

### **10.3 Using repeaters and addresses in the same system**

In systems with several repeaters, a substation and a base-station, addresses must be used in radio modems. It is possible to realise also a system with only one repeater without addressing. In such a case, the base station will however hear the message both from the substation and from the repeater, in other words the message is duplicated as it moves along the route.

There are at least two ways of realising such a system depending on the capabilities of the terminal devices in question and on the number of repeaters to be used and on their relative positions to each other.

#### **10.3.1 System with several repeaters**

In systems with several serial or parallel-chained repeaters, addressing must be used to prevent messages from ending up in loops otherwise formed by repeaters, and to ensure that only the desired (addressed) radio modem receives the data intended for it.

All radio modems in the network must be set to a state, in which the RX-addressing is switched ON and TX-addressing is switched OFF. Base-station and all substations add an address string in the beginning of the data to be transmitted. In the relaying of the message addressing is used in the following way:

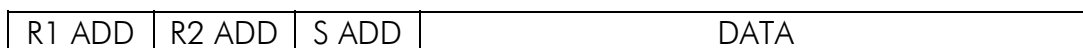

- The above is the data received from the base station terminal device, containing repeater addresses (R1 ADD, R2 ADD) and the substation address (S ADD). Two characters define each address.

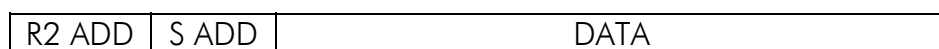

- The above is the same message after being relayed from repeater 1 to repeater 2.

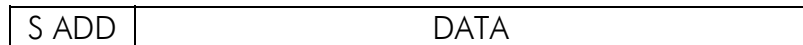

- The above is the same message after being relayed from the last repeater in the chain (repeater 2) to the substation.



- The above is the same message being relayed via the serial interface of the substation radio modem to the terminal device.

In a situation where the substation transmits data towards the base-station the address is formed in a similar way, but the order of the addresses is reversed:

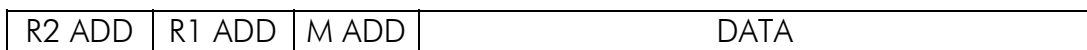

-In the above, R2 ADD is address of repeater 2, R1 ADD is address of repeater 1 and M ADD is the address of the base-station.

### 10.3.2 Repeater chain using address pairs

In a situation where the terminal devices and substations cannot form address fields, but are able to recognise messages addressed to them, alternating address pairs may be used. Transmit address (TX) and receive address (RX) alternate in the order shown in the table below.

Address type	Base-station address	Repeater 1 and the addresses of the substations of the base-station	Repeater 1 substations addresses
TX-address	Address 1	Address 2	Address 1
RX-address	Address 2	Address 1	Address 2

In a network where alternating addresses are utilised, the exact route that is used to relay a message to a certain radio modem is fixed at the time of installation and configuring the system. The order of the addresses must be the same as the order of the route that is used to relay the message to the said radio modem. It should be noted however, that in network where alternating addresses are used the base-station and substations will hear their own messages repeated.

### 10.3.3 Repeater chain using dual addressing

If the terminal devices cannot add address chains to the beginning of the data packets, a network with several repeaters may still be realised by using dual addressing. In dual addressing each link (see arrows below in figure) is given a unique address, which will prevent duplication of messages and endless loops in the network. The terminal devices need not add anything to the data.

Usually the primary transmit address is used in transmission (TX1). The secondary transmit address (TX2) is used only if the *Repeater Mode* is used and the packet to be repeated was received using the secondary reception address (RX2).

In the following example two repeaters are used. It should be noted that each link (arrow) might be uniquely defined with the help of radio modem numbers and data transfer directions. The *Repeater Mode* should be switched ON only in the radio modems acting as repeaters to prevent the packets from remaining in endless loops in the network.

Repeaters may also act as ordinary substations; in that case the terminal device must wait until the message has reached the end of the repeater chain before sending data.

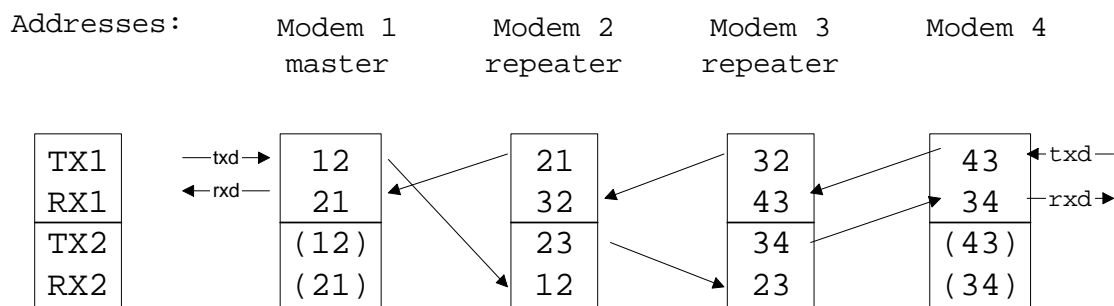

### 10.3.4 Redundant repeater chain

Reliability of a radio data communication system can be improved significantly by designing redundant equipment setup for master and repeater stations. The two repeater chains are separated by proper dual addressing setup. Slave stations need to be able to communicate with the master through the both repeater chains. By using the "TX address auto switch" function, the slave station modem directs the reply message to the repeater chain from which the request has been received.

If "TX address auto switch" has been set ON, radio modem checks out the RX address of the received message. When one of the RX addresses is recognised, all the messages coming in from the serial interface will be sent to the air with matching TX address. The use of "TX address auto switch" function is not recommended if Repeater Function is set ON.

## 11 MESSAGE ROUTING

### 11.1 Introduction to Message Routing

*Message Routing* is an exciting feature in SATELLINE-EASy Pro 35W. This feature allows messages from terminal devices to be automatically routed over the radio modem network to a specified recipient terminal.

In brief, the *Message Routing* works as follows:

- o First, a radio modem reads any message coming from the terminal(s) attached to it.
- o The radio modem detects the terminal address of the recipient, by seeking a pre-set position inside the message for the address.
- o The radio modem checks its internal route table to see, if there is route information corresponding the address it has just found.
- o The radio modem transmits a radio frame, which includes
  - o network id (see later)
  - o route information
  - o original user message encapsulated
  - o redundant information such as checksums for error checking etc.
- o The radio modems along the route relay the frame over the network to the radio modem at the destination.
- o The radio modem at the destination first checks the validity of the received radio frame, then extracts the original user message, and finally outputs it the terminal device attached to it.

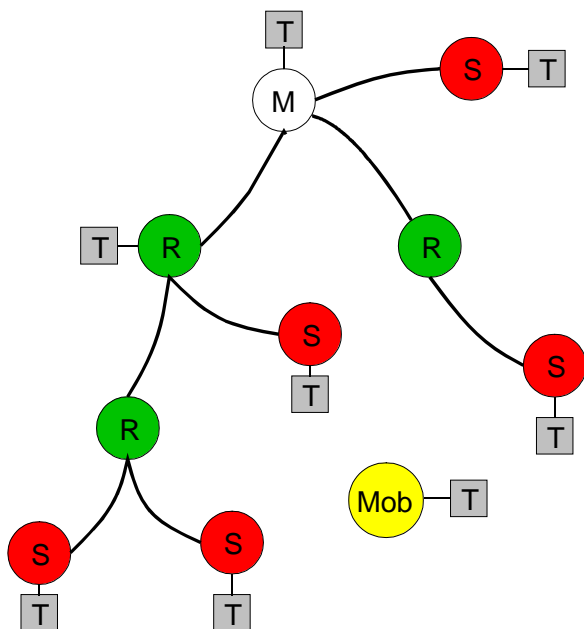

The figure left illustrates a possible structure of a radio modem network.

M = Master station (Central station)

R = Repeater station

S = Slave station

T = Terminal device

Mob = Mobile terminal

Terminals are usually PLC devices that send and receive messages according to a specific user protocol.

*Note:* The term *repeater* used in the context of the *Message Routing* should not be mixed with the *Repeater Mode*, which is a feature independent from the *Message Routing*.

### **11.1.1 Features of Message Routing**

The *Message Routing* feature of the SATELLINE-EASy Pro 35W is designed to be a fast and transparent to fit real time systems. The features include:

- o Transparent to user protocols.
- o Easy construction of a network containing several repeaters.
- o Any radio modem may operate as a repeater, i.e. dedicated repeaters are not usually needed thus cutting down on costs.
- o Large areas of coverage may be implemented by using only one radio channel.
- o The use of mobile substations is also possible to some extent.
- o The system will be fully deterministic i.e. the transmission delays are predictable. Because of that, the principle of *Message Routing* is connectionless.
- o Added redundancy, as a failing radio modem can be, in certain cases, bypassed with another radio modem positioned in the same coverage area.
- o *Message Routing* is intended mainly for the protocols based on polling scheme and a single master station.

### **11.1.2 Limitations of Message Routing**

- o It is assumed that the position of the address field in the user messages is fixed. However some special protocols are supported:
  - o IEC 60870-5-101 is a protocol commonly used in control applications of power lines.
  - o RP570 protocol
- o The message cannot end to the address; there must be at least one character after the address.
- o It is assumed that there is only one message at a time inside the network simultaneous messages could cause collisions.
- o The max number of the routes depends on the actual hardware and the Firmware version.
- o Operation of the Tx / Rx addresses is automatically blocked in the case of switching the "Message Routing" function on.

### **11.1.3 Getting started with Message Routing**

The design of any radio modem system requires very precise planning. Once the choices between devices, their location, installation, maintenance etc. are clear, the *Message Routing* for the system can be implemented.

Planning your *Message Routing* System

1. Decide which mode of the *Message Routing* suits the system - *Source Mode* or *Virtual Mode*. See the following paragraphs for details.

2. Design a layout of the system describing the settings such as protocol, addresses of the terminal equipment, radio frequencies and so on.

3. Configure the radio modems accordingly. There are two ways to configure the parameters related to the *Message Routing*:

1. SaTerm PC-program

2. Manual configuration in the setup menu.

In either case, please check the chapter on *Settings* before changing the setup of the radio modems.

Finally, when all the radio modems have correct settings, they are ready for further installation.

#### 11.1.4 **SaTerm and the configuration of the Message Routing**

*SaTerm* is a PC based program that allows the user to design their required network simply and quickly using a graphical interface to literally draw the network plan on the screen.

- o Firstly, a picture of the network is created to show all the radio modems and the intended route that the data is to take.
- o Secondly, the required settings are defined in the drawing.
- o Finally, the setup of each actual radio modem can be uploaded by connecting the actual radio modems one by one to the COM port, switching them to the programming mode, and clicking the transmit button of *SaTerm*.

Please check the user manual of *SaTerm* for more details.

The figure below shows a typical snapshot taken from a *SaTerm* screen.

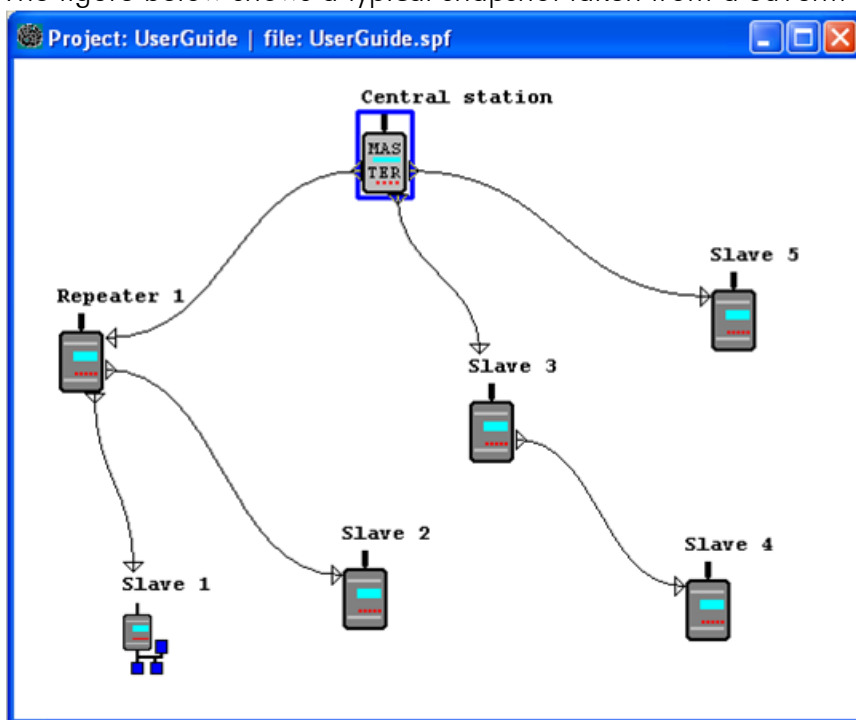

#### 11.1.5 **Manual configuration of the Message Routing**

The radio modems can be configured manually via the programming menu. However, this is recommended only if the structure of the network is very simple, or if it is desirable to define such special functions that are not possible to draw using the graphical interface of *SaTerm*. Examples of such cases are for example non tree-structured networks, or the use of same repeaters in several overlapping networks. The operation of the *Message Routing* must be clearly understood before configuring the radio modems manually.

### 11.1.6 Configuration of the protocol in Message Routing

A radio modem will detect the presence of an address used by inspecting the protocol from the message received via the serial interface. On the basis of this user address, all necessary information needed to relay the message to destination is fetched from an internal routing table inside a radio modem. The user protocol is not interpreted; instead, the user address is searched according to its location in the message. The beginning of the packet is located by a preceding pause in the byte stream. Message Routing can therefore be applied to most protocols with fixed address field position.

The position and length of the address is defined by two settings: *Offset* and *Length*.

- o Offset defines the number of bytes (0...15) preceding the address.
- o Length is the length of the address in the user protocol expressed in bytes (1...4).

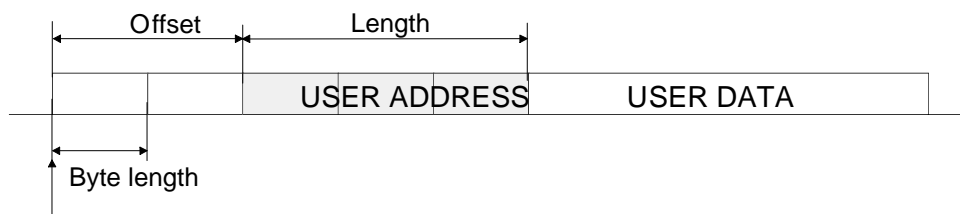

Start of data packet, Offset=2, Length=3

A transmitting radio modem adds a routing header and a tail to the user message. Consequently, a radio modem that receives the message removes the header and tail - so the Message Routing scheme is transparent to the user protocol.

## 11.2 Operating modes of Message Routing

The *Message Routing* has two different operating modes:

- o *Source Mode Routing*
- o *Virtual Mode Routing*

The most important differences between the two modes are shown in the table below.

Property	<i>Source Mode Routing</i>	<i>Virtual Mode Routing</i>
Summary	Slower, more functions	Faster, less functions
Radio interference tolerance	Yes, overhop function	No
Support for mobile stations	Yes	No
Addition of substations to a network	Only master station needs to be reconfigured	Master station and consecutive repeaters need to be reconfigured
Changing routes	Only master station needs to be reconfigured	All radio modems need to be reconfigured
Maximum length of route	13 hops	No limit
Overhop function	Yes	No
Network ID	Yes	Yes
Storing of routing information	Centralised	Dispersed
Message Routing overhead (bytes)	$10 + 2 * \text{number of hops}$	9
Maximum length of user protocol message (bytes)	1kB – Message Routing overhead	1kB – Message Routing overhead

Other issues common to the both modes:

- o The maximum number of terminals depends on the radio network structure and the number of routes.
- o Multiple terminal addresses may be attached to a radio modem.
- o The maximum length of a terminal address (in the user's protocol) is four bytes (FFFFFFFF in hexadecimal).
- o The maximum length of the address of a radio modem is two bytes (FFFF in hexadecimal).

## 11.3 Detailed description of Message Routing

### 11.3.1 Source Mode Routing

The above figure represents a network containing four (4) radio modems. Each radio modem is given a unique address (0...3). A terminal device has been attached to the three of the four radio modems and they communicate with each other using terminal addresses X, Y and Z, respectively. Radio modem 0 and terminal device X together constitute the base station of the network and all routing information of the network has been programmed into this base station.

When the terminal device X transmits a packet to (e.g.) terminal Y, radio modem 0 will detect the address Y from the data received through the serial port. From the routing table a route 1,2 can be found to which the radio modem also adds its own address to define the route for return data. Radio modem 1 repeats the packet and radio modem 2 removes the address information from the received data packet thereby transferring only the original data to the serial interface. The address information received together with the packet is reversed (2, 1, 0) and saved to be use in the transmission of subsequent reply packets.

### 11.3.2 Virtual Mode Routing

Please contact SATEL for more information of Virtual Mode Routing.

### 11.3.3 Overhop function in Source Mode Routing

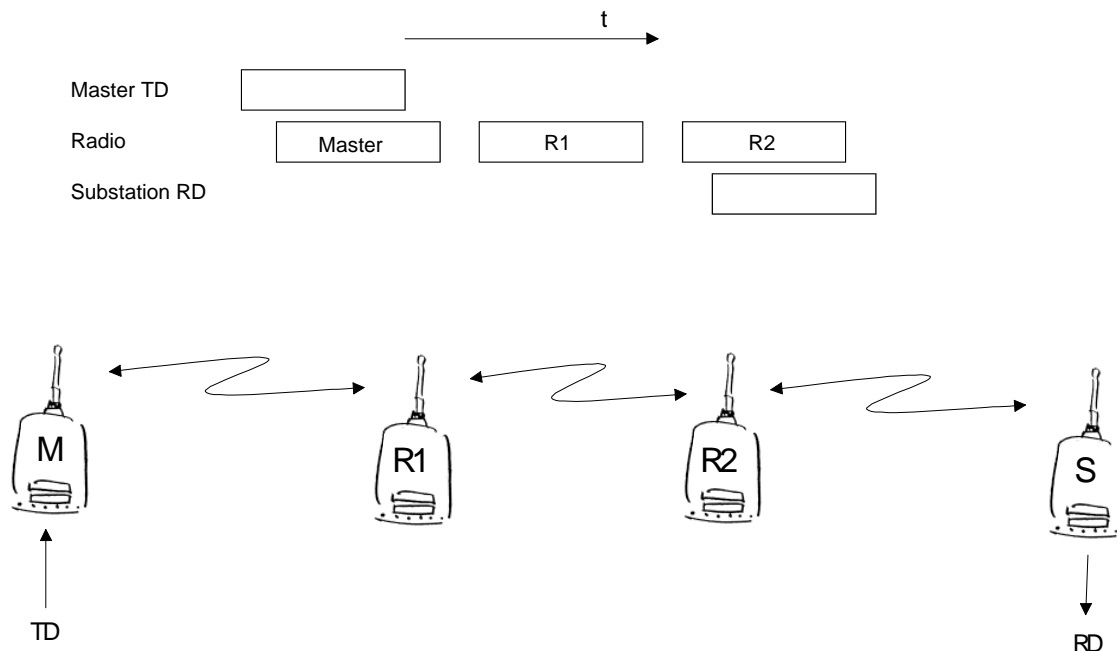

When using repeaters, the same packet is sent via a (radio) channel several times. A radio modem situated in the repeater chain will often hear other radio modems in addition to the immediate neighbouring radio modems. With *Source Mode Routing* the complete address information is sent together with the packets enabling the use of these secondary routes. Usually repeaters have better antennas (and/or antennas placed higher) than normal substations, which means that the distance between two repeaters can be much longer than the distance between a repeater and a substation.

Connections to other than the neighbouring stations of the repeater are not necessarily reliable under all possible (radio) conditions, but they can often be used to keep the network up and running at least partially should a repeater somewhere in the middle of the chain fail. In addition to this, the likelihood of a transmission error decreases if it is possible to listen to more than one transmission since; in this case, it is more likely that at least one of them will be received error-free. It is also possible, that the radio connection is asymmetrical due to the greater output power

of a repeater or due to local interference, in which case, data can in fact travel in opposite directions using different routes.

When a repeater receives a message that contains its address but not as the first address in the address field, the packet is stored in a buffer. If the relayed message from the repeater, and the modem having sent the message originally, is not received (due for example, because of radio modem failure or if it has an erroneous checksum), the packet already buffered into the memory is re-sent without any change to the timing (no additional delays are introduced). Because of this, relatively short hop distances can be used, without the likelihood of errors being increasing due to the added number of repeats. A possible error in one of the repeaters does not necessarily cause a total breakdown of traffic.

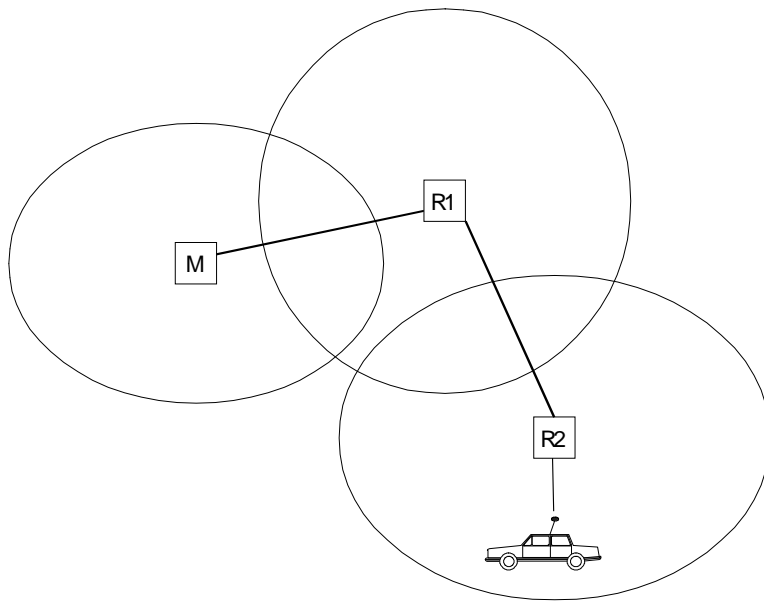

The overhop function allows for the use of mobile substations. In the example above, a mobile substation is first located in the coverage area of repeater R2. The route is defined as M, R1, R2 and vehicle. When the vehicle moves to the coverage area of repeater R1, the radio modem picks the packet already from the transmission of R1. This is then transferred to the serial port using an additional delay, so that the timing does not differ from the first situation where the radio modem of the vehicle was in the coverage area of repeater R2. In this way a collision of the reply transmission and the transmission by repeater R2 is prevented. When the mobile station is transmitting, it is enough that at least one radio modem defined to be a part of the route receives the transmission.

#### **11.3.4 Network ID**

The Network ID is a string of up to eight characters, which is used to prevent the reception of the messages coming from an external system. The radio modems operating in the same system using *Message Routing* must have the same Network ID. Only the messages that have a matching Network ID are received.

## 12 INSTALLATION

### 12.1 Installation of a Radio Data Modem

The radio modem should be installed with the installation accessories supplied with the radio modem.

**NOTE!**

When selecting a suitable location for the radio modem it must be ensured that no water can get into the radio modem under any conditions. Direct sunlight is also to be avoided. It is not recommendable to install the radio modem on a strongly vibrating surface. Suitable dampening and/or isolation materials should be used in cases where the installation surface will be subjected to vibration.

#### 12.1.1 RS-232 Wiring

NOTE! In SATELLINE-EASy Pro 35W the voltage is limited to 16V.

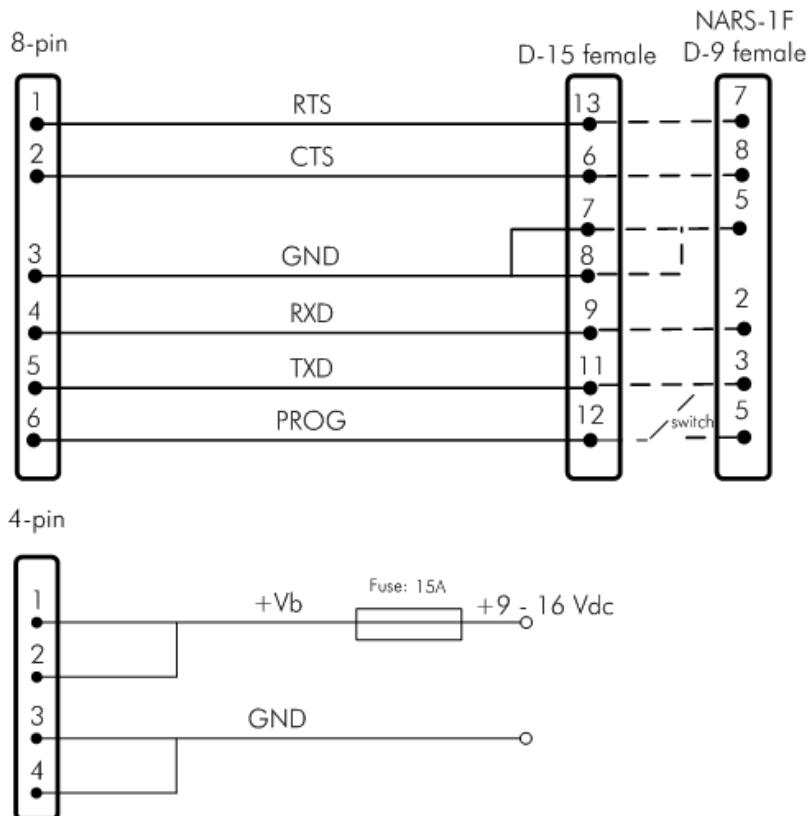

### **12.1.2 Fuse**

A proper fuse must be connected in between the radio modem and the power supply. The correct value is 15A for SATELLINE-EASy Pro 35W.

### **12.1.3 Power supply**

The allowed operating voltage is  $+9 \dots +16 V_{DC}$ . The radio modem must only be connected to a power supply with an adequate current output (power rating minimum is 120W). The pins 1 and 2 of the 4pin Odu-connector are connected to the positive power supply line. The pins 3 and 4 are connected to negative power supply line (ground).

## **12.2 Antenna installation**

### **NOTE!**

Because of the great transmission power of **SATELLINE-EASy Pro 35W** radio modem, only an external antenna is allowed. A whip-antenna directly connected to the antenna connector must not be used.

### **12.2.1 Mobile equipment**

- ¼-wave antenna
- ½-wave antenna

The ideal installation position is vertical, and there should be at least 0.5 m of free space around the antenna. In small systems a ¼-wave antenna is sufficient. A separate ground plane should be placed under the antenna (vehicle rooftop or the engine hood or trunk door are usually suitable). In problematic cases the most suitable type is a ½-wave antenna. It can be installed directly at the top of a pipe with the added benefit of gaining as much as free space around the antenna as possible. In cases, which the antenna cannot be directly connected to the TNC-connector of the radio modem, a coaxial cable with 50 ohm impedance must be used between the antenna and the TNC-connector.

### **12.2.2 Base stations**

- Omni-directional antennas ( ¼- , ½- or 5/8-wave antenna)
- Directional antennas (yagi /multi-element antenna or corner antenna)

The antenna should be installed in a vertical position. The exact location of the antenna depends on several factors, such as the size of the overall system and the coverage area terrain contours. A rule of thumb is that the base station antenna should be located at the highest point of the coverage area and as close to the centre of the coverage area as possible. The base station antenna can also be located inside a building, if the walls of the building do not contain metal.

### **12.2.3 General antenna installation instructions**

The reliability and the achievable coverage of useful signal strength can be severely affected by the positioning of the antenna. Antenna and cable connectors should have gold-plated pins and sockets, as use of low quality connectors can lead to eventual oxidation of the connector surfaces, which in turn may degrade the contact and cause additional attenuation. Good quality tools and materials must be used when installing radio modems, antennas and cables. The weather tolerance of the materials used must also be taken into account. Installed materials must withstand all foreseeable weather conditions (frost, excess sun, direct UV-radiation, seawater etc.). Also possible environmental pollution must be considered (acids, ozone etc.).

Antennas must be installed well away from metallic objects. In the case of small antennas this distance should be at least ½ m. With large antennas the distance should be >5 m and in case of repeater antenna combinations >10 m.

If the system contains a large number of radio modems, the best location for an antenna is the highest point of a building and possibly an additional antenna mast. If a separate antenna mast is used, the antenna can, if necessary, be installed sideways about 2...3 m from the mast itself.

When installing an antenna possible interference sources must be considered. Such interference sources are, for example:

- o mobile telephone network base station antennas
- o public telephone network base station antennas
- o television broadcast antennas
- o radio relay antennas
- o other radio modem systems
- o PC-related devices (approximately 5 m radius from antenna)

When ordering antennas we request you to note that antennas are always tuned to a specific frequency range. Simple antennas and antennas, which have been constructed of stacked yagi-antennas, are typically rather broadband. As the number of yagi-elements increases the frequency range becomes narrower. Note this specially with 35W.

When designing and installing a system it is advisable to prepare to test the system, and also to consider serviceability of the system. In particular cabling should be planned to allow easy access and to allow for maintenance. It is often practical to use long antenna cables, so that the radio modem can be installed far enough from the antenna itself to a location that is easily accessible (see section 10).

The type of the antenna cable is dependent on the length of the antenna cable, and the following table can be used to select a suitable type:

Length	Type	Attenuation 10m/450MHz
<5m	RG58	3.0dB
0...20m	RG213	1.6dB
>20m	ECOFLEX10	0.9dB
>20m	AIRCOM+	0.8dB*
>20m	ECOFLEX15	0.6dB

\*) AIRCOM+ cable is partially air insulated, so the use of this cable requires that the connection between the cable and the connectors are fully airtight.

If there is a line-of-sight path between the antennas a 6 dB power marginal is usually adequate. However, if the connection is built on the reflection and/or the knife-edge diffraction the path loss can vary even 20 dB depending on the weather conditions. In this case a short test can give a too positive result of the quality of the connection. Thus the height of the antennas and topographical obstacles must be surveyed with great care. From time to time a marginal connection can be used

if the data transmission protocol is well prepared for this and the data transmission that occasionally slows down does not cause any problems to the system.

Vertical polarised antennas (antenna elements are in vertical position) are often used in radio systems. In a system between a base station and substations vertical polarisation is recommended. The radio modem antenna cannot be mounted on the same level as the other substation antennas in the same building. The best way to distinguish from the other antennas situated in the neighbourhood is to mount the antennas as far as possible from each other on the altitude level. The best result is generally obtained when all the antennas are in the same mast. With an extra ground plane between the antennas more distinction can be obtained between the antennas in the mast.

Horizontal polarisation can be used in data transmission between two points. With the polarisation attenuation more distinction is obtained to vertical polarised systems. The influence of the directional patterns of the antennas must, however, be taken into consideration. If a distinction to another interfering antenna is wanted with the horizontal polarised antennas there must be a good attenuation of the back lobe. In addition to this the interfering radiator should be situated behind the antenna.

When a system does not demand the use of an omni-directional antenna it is recommended that directional antennas are used e.g. two-element yagis in permanent external installations. Please note that as antenna amplification increases the setting of the direction of the antenna requires more attention.

Base stations in high places should be supplied with high-Q cavity filters. Please note that the higher the base station antenna, the larger the coverage area and in turn that the risk of interference is also increased.

SATEL recommends the use of a band-pass filter with a large Q in the antenna cable of the base station.

**Example of an antenna installation:** by using amplifying antennas ( $G$ =Gain) and by installing the antenna high, long connection distances can be realised using the SATELLINE-EASy Pro 35W radio modem.

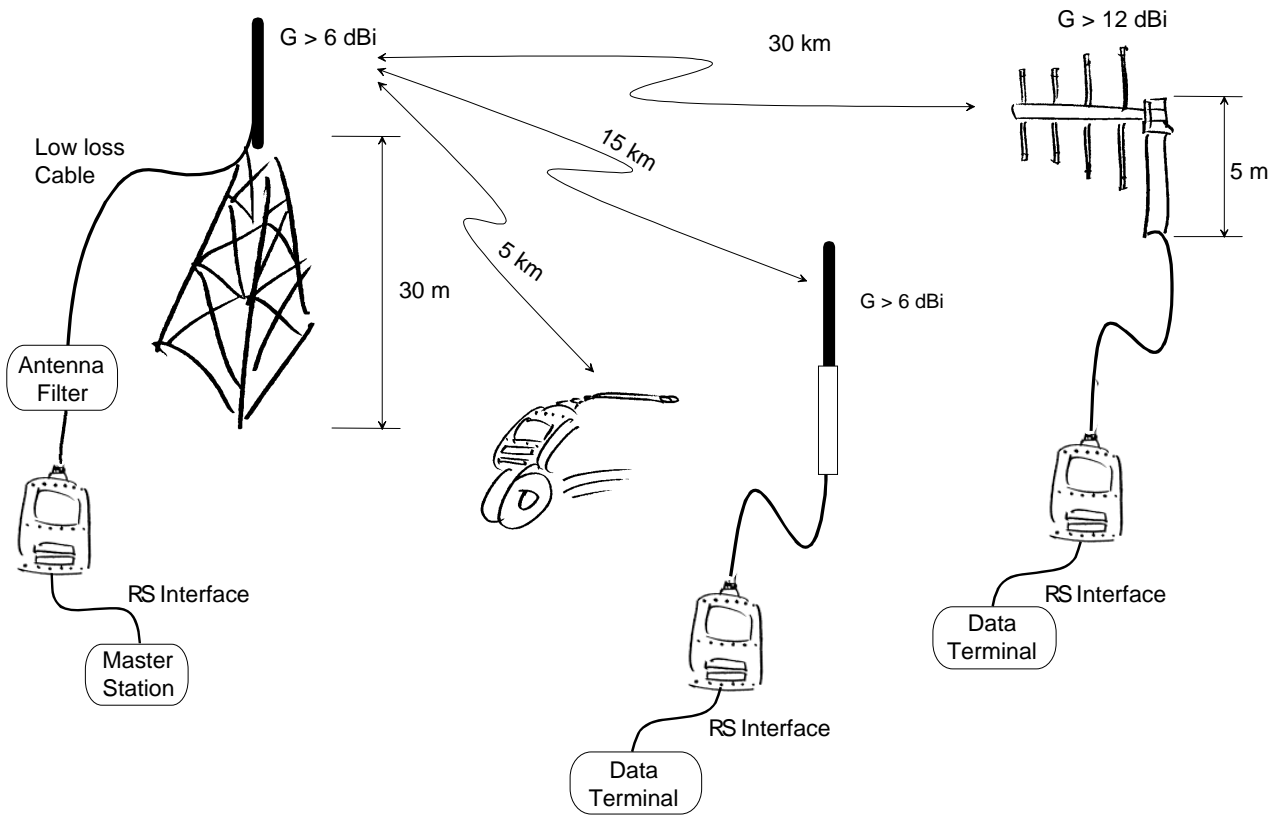

## 13 DESIGNING SYSTEMS

### 13.1 Factors affecting the quality and distance of the radio connection

- power of the radio transmitter
- sensitivity of the radio receiver
- tolerance of spurious radiation's of the radio modulating signal
- amplification of transmitting and receiving antennas
- antenna cable attenuation
- antenna height
- natural obstacles
- interference caused by other electrical equipment

The transmitter power of the SATELLINE-EASy Pro 35W is 35 W (maximum) and the sensitivity of the receiver better than -114 dBm. Thus in a flat area and in free space with a 1/4 wave antenna (antenna amplification 1dBi) and antenna height of 1 m communication distances of 3 to 4 km can be achieved. Distances may be considerably shorter in situations where there are metallic walls or other material inhibiting the propagation of radio waves.

Over long distances, increasing the height of antennas can often solve problems caused by natural obstacles. A ten-fold increase in distance can be achieved with the use of amplifying antennas. Frequent topographical variations over long distances may require that at least one of the antennas be raised to a height of 10 to 20 m.

If the antenna cable is more than 10 meters long it is necessary to use a low loss cable (< 0.7 dB /10 m) in order not to waste the antenna amplification. Adding a repeater station can also solve problematical radio connections. In systems with many base stations the RSSI-signal can be used to assist in choosing the base station with the best signal. A communications network can also be built with a combination of cables and radio data modems.

The SATELLINE-EASy Pro 35W operates in the 450 MHz band, where man made interference is insignificant. Long distance interference needs not to be taken into account even in special weather conditions.

The SATELLINE-EASy Pro 35W tolerates normal levels of interference that occur. However, exceptionally high levels of interference can break through the safeguards and thus cause errors in data transfer. In mobile vehicle applications the range of operation can be increased by dividing the transmitted data into e.g. 50...500 byte long blocks and by re-transmitting the defected blocks.

A sufficient safety margin can be obtained by testing the communication path using extra 6 dB attenuation at the antenna connection and with slightly less effective antennas than those to be used in the final system.

## **13.2 Radio field strength**

Radio signal strength must be good enough for successful data transfer. Where field strength is above a certain level, the operational results are very good. Below this level, a few dB marginal areas occur in which errors begin to be generated by noise and interference that will eventually lead to loss of connection.

The field strength is at its optimum level in open space, although increasing distance will still reduce it. It must also be remembered that one open space has different environmental and external factors to another, and that the effects on transmission quality must be taken into account when planning the system.

Ground, ground contours and buildings cause attenuation (loss of energy through absorption) and reflection of radio waves. Buildings reflect radio waves and therefore the affects of attenuation are not as acute when transmission is over a short distance.

However, the reflected waves will often be a bit delayed, and when they combine with the direct radio waves they interact in either a weakening or a strengthening way. This causes the fading effect in mobile systems. In reality very sharp signal drops spaced about 35 cm apart may occur. The attenuation may even reach 40 dB, normally less.

## 14 CHECK LIST

The following points must be taken into account when installing and configuring a radio modem:

1. All operating voltages of all the equipment concerned must always be switched OFF before connecting the serial interface cable.
2. When considering the exact placement of a radio modem and/or its antenna, the following points must be taken into account to guarantee optimal results:
  - o The antenna should be installed in open space as far as possible from any possible sources of interference
  - o The radio modem should not be installed onto a strongly vibrating surface
  - o The radio modem should be installed in such a way as to minimise exposure to direct sunlight.
3. To ensure reliable operation the voltage output of the power supply used must be stable enough and the current capability of the power supply must be sufficient.
4. The antenna must be installed according to instructions.
5. *Serial interface settings between the radio modem and the terminal unit must correspond to each other.*
6. All radio modems in the same system must be configured using same settings (radio frequency, channel spacing and data field length).

## 15 ACCESSORIES

### 15.1 RS-232 cables and adapters

Type	Description
ODU/D9f	8 pin ODU / D9 female (universal). Power supply cable and programming switch
NARS-ST	8 pin; for EASy Pro 35W

### 15.2 Power cable

Type	Description
C-P-35W	2m cable, ODU 4-pin male / 4mm lab plug

### 15.3 RF-cables

Type	Description	Length	Note
CRF-1	Cable with TNC m/TNC f-connectors	1 m	RG58 (3 dB/10 m)
CRF-5F	Cable with TNC m/TNC f-connectors	5 m	RG58 (3 dB/10 m)
CRF-5M	Cable with TNC m/TNC m-connectors	5 m	RG58 (3 dB/10 m)
CRF-15	Cable with TNC f/TNC f 90-degree connector	15 cm	RG58 (3 dB/10 m)
RG213	Low loss cable	X	1.6 dB/10 m
ECOFLEX10	Low loss cable	X	0.9 dB/10 m
AIRCOM+	Low loss cable	X	0.8 dB/10 m
ECOFLEX15	Low loss cable	X	0.6 dB/10 m

Note! In the description, m=male, f=female connector type.

## 15.4 Antennas

Type	Description
CA420O	Omnidirectional coaxial dipole, 2 dBi, 405-440 MHz
CA450O	Omnidirectional coaxial dipole, 2 dBi, 440-475 MHz
CA405GP+	Omnidirectional ground plane, 6 dBi, 401-409 MHz
CA410GP+	Omnidirectional ground plane, 6 dBi, 406-414 MHz
CA420GP+	Omnidirectional ground plane, 6 dBi, 416-424 MHz
CA430GP+	Omnidirectional ground plane, 6 dBi, 426-434 MHz
CA435GP+	Omnidirectional ground plane, 6 dBi, 431-439 MHz
CA440GP+	Omnidirectional ground plane, 6 dBi, 436-444 MHz
CA445GP+	Omnidirectional ground plane, 6 dBi, 441-449 MHz
CA450GP+	Omnidirectional ground plane, 6 dBi, 446-454 MHz
CA460GP+	Omnidirectional ground plane, 6 dBi, 456-464 MHz
CA470GP+	Omnidirectional ground plane, 6 dBi, 465-475 MHz
CA400Y	Directional yagi, 6 dBi, 380-410 MHz
CA420Y	Directional yagi, 6 dBi, 405-440 MHz
CA450Y	Directional yagi, 6 dBi, 440-475 MHz
CA400Y+	Directional yagi, 8 dBi, 380-410 MHz
CA420Y+	Directional yagi, 8 dBi, 405-440 MHz
CA450Y+	Directional yagi, 8 dBi, 440-475 MHz

SATEL antenna selection includes also directional and/or omni-directional antenna. These can be supplied separately on request.

## 15.5 Filters and lightning protectors

If a radio modem system is installed in an environment that contains high-power transmitters or sources of radio frequency interference, it is highly recommendable to insert suitable filters between each radio modem and its antenna. If a station is installed to a location exposed to lightning, it is recommended to insert a lightning protector to the feed-line outside the protected zone. SATEL Technical Support can give guidance in the selection of suitable products.

## 16 APPENDIX A

ASCII CHARACTER TABLE														
D	H	A	D	H	A	D	H	A	D	H	A	D	H	A
0	0	NUL	43	2B	+	86	56	V	129	81		172	AC	
1	1	SOH	44	2C	,	87	57	W	130	82		173	AD	
2	2	STX	45	2D	-	88	58	X	131	83		174	AE	
3	3	ETX	46	2E	.	89	59	Y	132	84		175	AF	
4	4	EOT	47	2F	/	90	5A	Z	133	85		176	B0	
5	5	ENQ	48	30	0	91	5B	[	134	86		177	B1	
6	6	ACK	49	31	1	92	5C	\	135	87		178	B2	
7	7	BEL	50	32	2	93	5D	]	136	88		179	B3	
8	8	BS	51	33	3	94	5E	^	137	89		180	B4	
9	9	HT	52	34	4	95	5F	_	138	8A		181	B5	
10	A	LF	53	35	5	96	60	`	139	8B		182	B6	
11	B	VT	54	36	6	97	61	a	140	8C		183	B7	
12	C	FF	55	37	7	98	62	b	141	8D		184	B8	
13	D	CR	56	38	8	99	63	c	142	8E		185	B9	
14	E	SO	57	39	9	100	64	d	143	8F		186	BA	
15	F	SI	58	3A	:	101	65	e	144	90		187	BB	
16	10	DLE	59	3B	;	102	66	f	145	91		188	BC	
17	11	DC1	60	3C	<	103	67	g	146	92		189	BD	
18	12	DC2	61	3D	=	104	68	h	147	93		190	BE	
19	13	DC3	62	3E	>	105	69	i	148	94		191	BF	
20	14	DC4	63	3F	?	106	6A	j	149	95		192	C0	
21	15	NAK	64	40	@	107	6B	k	150	96		193	C1	
22	16	SYN	65	41	A	108	6C	l	151	97		194	C2	
23	17	ETB	66	42	B	109	6D	m	152	98		195	C3	
24	18	CAN	67	43	C	110	6E	n	153	99		196	C4	
25	19	EM	68	44	D	111	6F	o	154	9A		197	C5	
26	1A	SUB	69	45	E	112	70	p	155	9B		198	C6	
27	1B	ESC	70	46	F	113	71	q	156	9C		199	C7	
28	1C	FS	71	47	G	114	72	r	157	9D		200	C8	
29	1D	GS	72	48	H	115	73	s	158	9E		201	C9	
30	1E	RS	73	49	I	116	74	t	159	9F		202	CA	
31	1F	US	74	4A	J	117	75	u	160	A0		203	CB	
32	20	SP	75	4B	K	118	76	v	161	A1		204	CC	
33	21	!	76	4C	L	119	77	w	162	A2		205	CD	
34	22	"	77	4D	M	120	78	x	163	A3		206	CE	
35	23	#	78	4E	N	121	79	y	164	A4		207	CF	
36	24	\$	79	4F	O	122	7A	z	165	A5		208	D0	
37	25	%	80	50	P	123	7B	{	166	A6		209	D1	
38	26	&	81	51	Q	124	7C		167	A7		210	D2	
39	27	'	82	52	R	125	7D	}	168	A8		211	D3	
40	28	(	83	53	S	126	7E	~	169	A9		212	D4	
41	29	)	84	54	T	127	7F		170	AA		213	D5	
42	2A	*	85	55	U	128	80		171	AB		214	D6	

## 17 APPENDIX B

### 17.1 Functional delays

Function	Delay (ms)
Wakeup time from STAND-BY to ON (controlled by DTR line)	123 ms (CTS active)
Wakeup time from Power OFF -> Power ON (=ready to receive)	123 ms/typical
Serial interface, turnaround time of RS-232	0
TX-mode: Wakeup time from SLEEP to modem ready (triggered by IRQ-data when Data in TD-input).	60ms, typical
RX-mode: Wakeup time from SLEEP to modem ready (triggered by IRQ-data when Data in TD-input).	40ms, typical
RD - TD turnaround wait, if RX freq. $\neq$ TX frequency.	> 20ms app. > 40 ms recommended for compatibility prior to other 3AS-family members.
TD - TD turnaround wait if TX frequency changes.	> 20ms app. > 40 ms recommended for compatibility prior to other 3AS-family members.
SL-Ping response time from remote modem	222 ms, modem to modem w/o repeaters

### 17.2 Transmission related delays

Delay from the end of transmission to the end of reception on the serial interface:

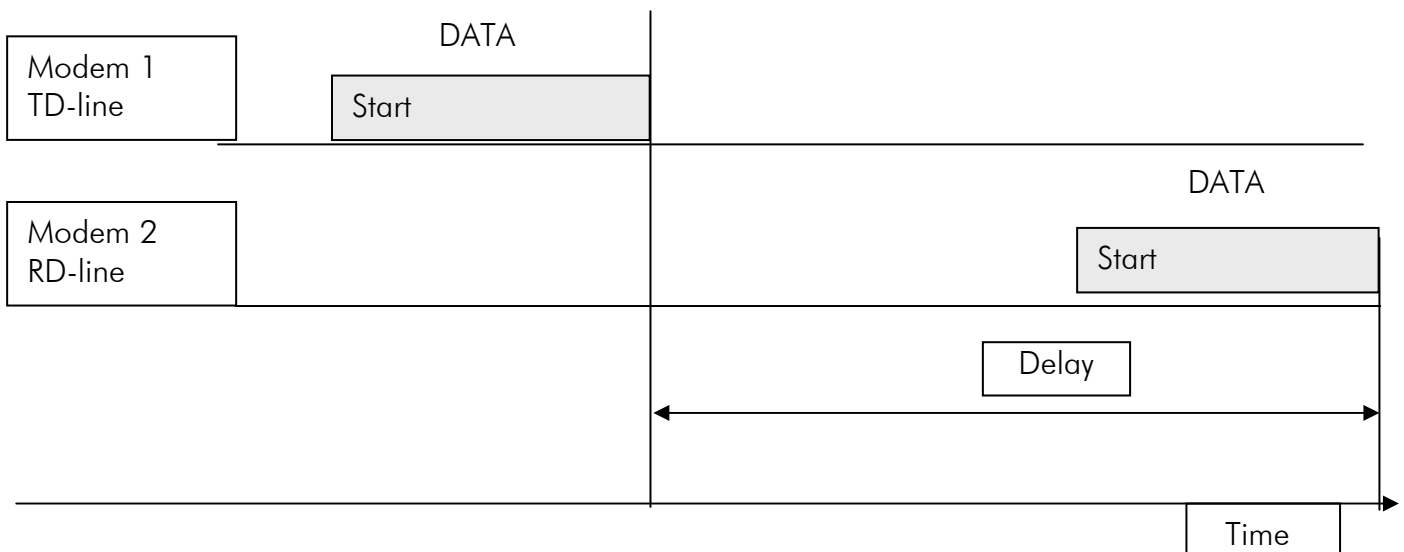

**17.2.1 Transmission delays when the radio TX frequency is changed**

- If the modem’s transmitter frequency (TX) is different than the receiver frequency (RX), there has to be at least 40 ms delay from the Receive Data (RD) to Transmit Data (TD).
- If the transmitter frequency is changed by an SL-command, there has to be at least 40 ms delay after the SL-command before the Transmit Data.
- If the transmitter frequency is changed from TX1 to TX2 by an SL-command during the transmission, there has to be at least 40 ms delay after the SL-command before the Transmit Data.

**17.2.2 Transmission delays when using a 12.5 kHz radio channel**

Transmission delays without FEC-function (Forward Error Correction).

Number of bytes sent

Bps	1	10	100	500
1200	40	40	29	22
4800	34	34	31	22
9600	32	32	32	27
19200	32	35	64	193
38400	32	36	91	352

Delays are in milliseconds and with a 10% margin.

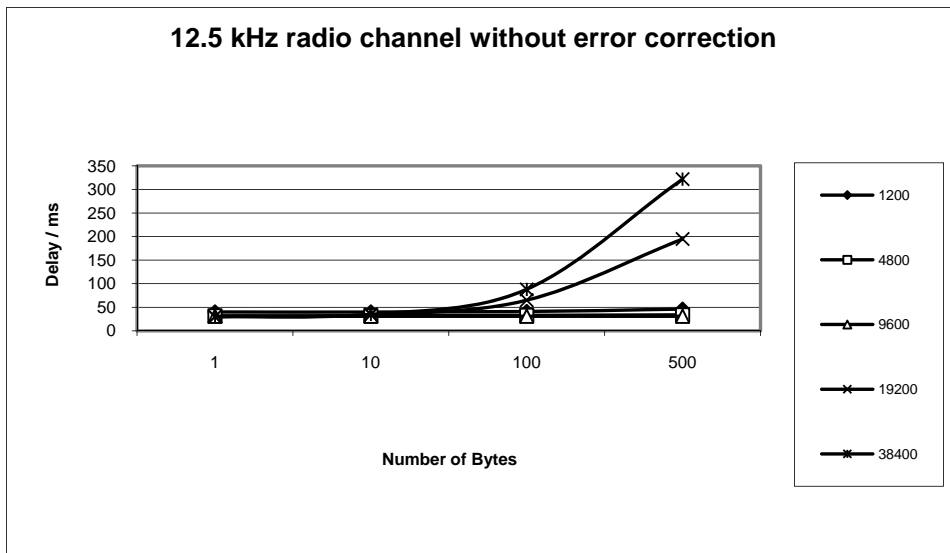

Transmission delays with FEC-function (Forward Error Correction).

Number of bytes sent

Bps	1	10	100	500
1200	52	49	48	50
4800	45	45	44	44
9600	44	44	68	121
19200	44	44	104	360
38400	48	48	132	496

Delays are in milliseconds and with a 10% margin.

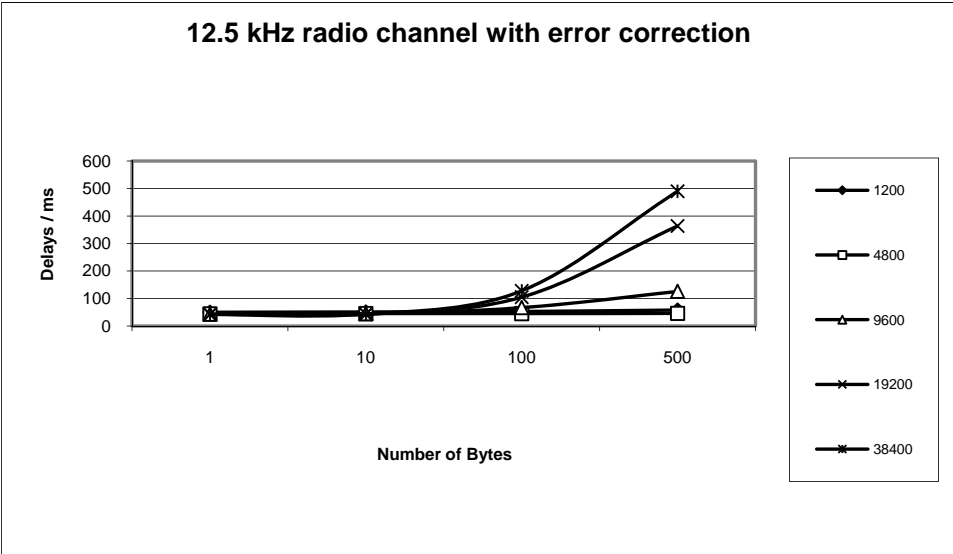

**17.2.3 Transmission delays using a 25 kHz radio channel**

Transmission delays without FEC-function (Forward Error Correction).

		Number of bytes sent			
Bps	1	10	100	500	
1200	30	30	18	16	
4800	23	23	21	12	
9600	23	23	21	17	
19200	22	22	22	19	
38400	22	22	38	102	

Delays are in milliseconds and with a 10% marginal.

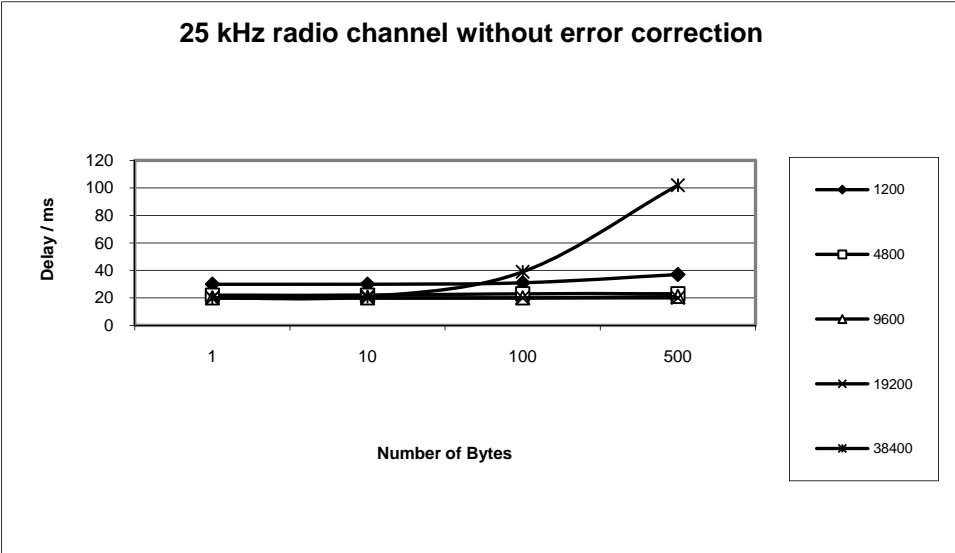

Transmission delays with FEC-function (Forward Error Correction).

Number of bytes sent

Bps	1	10	100	500
1200	35	34	29	30
4800	28	28	27	23
9600	28	28	28	23
19200	28	28	36	64
38400	27	27	58	185

Delays are in milliseconds and with a 10% margin.

